  
mitoredlight

 mitoredlight

# USER MANUAL

MitoPRO X Series

[www.mitoredlight.com](http://www.mitoredlight.com)

© 2023 Mito Red Light, Inc. All rights reserved.



# TABLE OF CONTENTS

ABOUT US .....	<b>3</b>
GETTING STARTED .....	<b>4</b>
CONTRAINDICATIONS .....	<b>5</b>
FAQS .....	<b>7</b>
GETTING STARTED: MITOPRO X SERIES .....	<b>10</b>
MOBILE APP USER GUIDE .....	<b>17</b>
MITOPRO X MULTIPLE PANELS .....	<b>20</b>
MITOPRO X MASTER CONTROLLER .....	<b>21</b>
MITOPRO X FLOOR STAND INSTRUCTIONS .....	<b>22</b>
MITOPRO X XL PANEL .....	<b>23</b>
VERTICAL STAND BRACKET PLACEMENT .....	<b>25</b>
HORIZONTAL STAND BRACKET PLACEMENT .....	<b>27</b>
LIGHT THERAPY OVERVIEW .....	<b>28</b>
SAFETY INSTRUCTIONS, WARNINGS, AND DISCLAIMER .....	<b>31</b>
CAUTIONS & DISCLAIMER .....	<b>33</b>
WARRANTY POLICY.....	<b>34</b>
REFUND POLICY .....	<b>35</b>

# ABOUT US

Located in Scottsdale, Arizona, **Mito Red Light**® is dedicated to bringing the highest powered, highest quality red light therapy lights to market at the best possible value.

Having extensively studied and realized the benefits of red light therapy firsthand, Mito Red Light was brought into existence in order to provide consumers truly affordable, yet highly effective red light therapy options.

If you have any further questions, please feel free to contact us at: **[info@mitoredlight.com](mailto:info@mitoredlight.com)**

You can also call our phone number  
Monday - Friday 9am - 5pm MST  
**+1 866-861-6486**

Mail correspondence can be sent to:

Mito Red Light, Inc  
9319 N 94th Way, Suite 400  
Scottsdale, AZ 85258

# GETTING STARTED

## INDICATIONS FOR USE

Mito Red Lights are general wellness devices and are not intended to cure or diagnose any medical conditions. Use of this device is designed to help promote overall health and wellness by supporting cellular function. Mito Red Lights should only be operated based on the user guidelines, as outlined in this user manual.

## FIRST TIME USERS

For first time users, we recommend starting out with 2-3 minute sessions per area, and slowly working up to a 10-minute session over the course of 2-3 weeks as your body acclimates to the therapy.

## STANDARD USE

**MitoPRO X Series:** We recommend 10-minute sessions at 12-18 inches from your device.

Additional 10-minute sessions for specific areas may be beneficial but beyond a certain point, the scientific evidence points to diminishing returns. More is not always better.



For this reason, we recommend you allow at least 6 hours between sessions on the same area. We recommend no more than 15 minutes in any one session. We recommend using the device 4-10 times per week. We recommend taking at least one day off per week.

Because the LEDs are very bright, eye protection should be worn when looking directly towards the light, particularly when NIR is active.

## MAINTENANCE

The Mito Red Light® does not require any maintenance beyond basic care and regular cleaning. Cleaning the light is easy, just unplug the light and wipe the surface with a cloth or paper towel. Do not use harsh cleaning chemicals or bleach because they may damage the light. Make sure the light is dry before using it again. For safety, the light is only intended for use indoors.

# CONTRAINDICATIONS

## CONTRAINDICATIONS FOR RED LIGHT THERAPY

There are no industry-wide accepted contraindications for red light therapy or list of accepted contraindications that is designated or enforced by regulatory agencies. Research in red light therapy is ongoing, and contraindications are derived from existing research and clinical inferences.



## POTENTIAL HAZARDS

**Heat** - Red light therapy will generate thermal energy as light is absorbed. This heat may present a hazard in some conditions.

**Light** - The electromagnetic radiation used in red light therapy is low in energy, but it may affect tissues that are sensitive to light.

**Tissue Stimulation** - Red light therapy is intended to stimulate tissues. In some disease states this may be undesirable.

## ABSOLUTE CONTRAINDICATIONS

**Recent Burns** - Recent burns may still contain residual thermal energy that may be increased by heat from red light therapy.

**Malignant Cancers** - There is a theoretical risk that red light therapy may increase cell proliferation in malignant cancers.

**Hyperthyroidism (Neck & Upper Chest)** - Red light therapy on the neck and upper chest may increase thyroid activity in those with hyperthyroidism.

**Pregnancy (Abdomen)** - The effects of red light therapy that reaches a developing fetus are not fully understood and may potentially have a negative effect.

**Eye Disease (Eyes)** - Red light therapy's effects on various eye conditions is not fully understood and light sensitive cells in the eyes may respond unfavorably to intense red light.

Light Sensitivity - Individuals with rare conditions causing extreme sensitivity to light or who have previously reacted to red light therapy should avoid its use.

## RELATIVE CONTRAINDICATIONS

Fever or Infection - There is a theoretical risk that the use of red light therapy can worsen existing hyperthermia caused by fever or infection.

Systemic Lupus Erythematosus (SLE) - SLE can cause skin sensitivity, increasing the risk of a reaction to red light therapy.

Severe Bleeding or Blood Loss - Some research suggests that red light therapy may slow the body's ability to stop bleeding.

Use of Photosensitizing Medications - Medications that increase sensitivity to light may increase risks of sensitivity to red light therapy.

Tattoos - Red light therapy may cause cosmetic defects to body art, especially body art that uses red inks may be prone to fading when exposed to intense red light. The tattoo ink may also cause uneven absorption of red light, causing therapy to be less uniform.

Dark skin pigmentation - The effect of skin pigmentation on red light therapy is still being studied. Those with darker skin tones

may find that their skin absorbs more light, making it warmer than those with lighter skin tones would experience. A smaller amount of red light may actually reach deeper tissues, however, this effect is not likely to be large.

Dark hair - Darker colors of hair may absorb more light, causing increased warmth and decreased penetration of red light. This effect is not likely to be large.

Melasma / Hyperpigmentation - Our own product study showed improvement from red and NIR light on hyperpigmentation, particularly when paired with a high antioxidant serum. However, in rare instances users can experience the opposite effect. We suggest starting slowly and using red light only if this is a concern.

A detailed discussion of this can be found in our article: [Red Light Therapy & Hyperpigmentation](#).

---

Anyone with a contraindication to red light therapy (or any health condition at all) should consult with their physician before using red light therapy.

## FAQS

### **IS RED LIGHT THERAPY SAFE? ARE THERE SIDE EFFECTS?**

Mito Red Light uses only the red and near infrared wavelengths that are clinically proven to be effective and safe. However, we always recommend consulting with your healthcare provider for specific questions about any concerns or health conditions.

### **DO I NEED SAFETY GLASSES WITH THIS LIGHT?**

While there is a growing body of scientific research suggesting that modest amounts of red and NIR LED light may benefit certain eye conditions, Mito Red's plug-in lights are very bright! As such, eye protection is provided and should be worn when facing the lights, particularly when NIR is active.



---

### **WHEN USING, DO NOT STARE DIRECTLY INTO THE LIGHT EMITTING DIODES (LEDS).**

Again, our Mito Red Lights are very bright and if you have any eye problems, or any other health conditions at all, please consult with a licensed healthcare professional before using a device like Mito Red.

# FAQS

## ARE THE NIR LEDS NOT WORKING?

NIR is just beyond the visible spectrum and is invisible to the naked eye. You will only actually be able to see a pink dot, or a subtle pink glow emanating from the LEDs when they are on. Please rest assured that there is a significant amount of light energy emanating from those LEDs and your Mito Red Light is in fact working exactly as designed.

Helpful tip: For peace of mind, take out your phone and take a picture of your panel with the NIR on only. You will see the bulbs illuminating.

Please note: The 'yellow' 590 nm light may look green as the eyes and brain adjust to the bright light. It is completely normal for the 590nm LEDs to appear green at times.



Panel off  
(through camera lens)

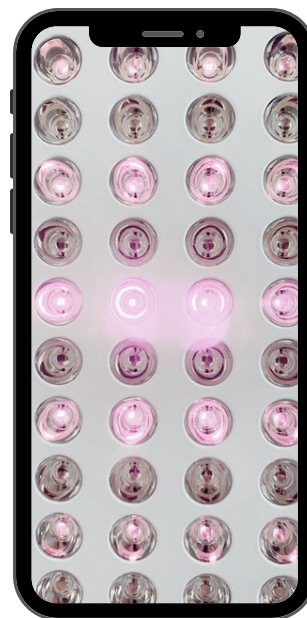

NIR on only  
(through camera lens)

## WILL LIGHT THERAPY TREATMENTS CAUSE DETOX SYMPTOMS?

It is possible that a Mito Red Light session can cause some detox related symptoms while your body acclimates. If you experience these types of issues, we recommend stopping use until the symptoms go away. Then start out at 2-3 minutes per session area and work your way slowly up to 10 minutes over the course of 2-3 weeks. This will help your body adapt... (continue to next page)



... If you continue to experience detox-related symptoms and have any concerns regarding the use of red light therapy, we recommend stopping use and consulting with your healthcare provider.

We have a full 60-day no hassle trial and full refund policy.

### **WHAT IF MY SKIN IS BURNED OR DAMAGED?**

Red light therapy has been clinically-proven to help damaged skin heal from cuts, burns, and other blemishes. We recommend consulting with your healthcare provider if you have any concerns.

As we are not licensed healthcare practitioners, we are not able to offer definitive clinical guidance. We recommend consulting with your trusted health care provider with specific questions.

### **WHAT IF I HAVE A PRE-EXISTING HEALTH CONDITION OR TAKE MEDICATIONS?**

Mito Red Lights are classified as a general wellness devices. Out of an abundance of caution, we recommend you consult with your healthcare provider if you have any pre-existing conditions or if you take photosensitizing drugs. Steroids work to suppress the immune system while red light therapy may work to stimulate it. To the extent that the two therapies may work against each other, we do not recommend they be used together.

### **CAN CHILDREN USE MITO RED LIGHT®?**

Clinical studies have shown red and NIR light therapy to be quite safe. However, if you are considering using it with children, we recommend consulting with a healthcare professional. All treatments with children should be done under adult supervision.

### **CAN PREGNANT OR NURSING WOMEN USE THE LIGHTS?**

As there has been no clinical research with red light therapy treatments on pregnant or nursing subjects, do not use the device if pregnant or lactating before consulting with your healthcare provider.

### **OTHER CONSIDERATIONS: BOTOX, BREAST IMPLANTS AND LASIK**

Users with a history of facial fillers and/ or Botox injections should consult their dermatologist prior to use.

Users with breast implants should consult their plastic surgeon prior to use.

Do not use the device during the healing period post Lasik eye surgery. Before resuming use, we recommend getting clearance from your doctor. As always, we recommend following our user guidelines and making sure to use the provided goggles when facing directly into the light panel.

## GETTING STARTED: MitoPRO X Series

**Step 1:** Unbox your MitoPRO X device and accessories:



- 1 x user manual
- 1 x power cord
- 1 x eye protection goggles
- 1 x eye protection glasses
- 1 x over the door hook
- 1 x hanging cables
- 2 x small vinyl straps
- 2 x large vinyl straps

**Step 2a:** If you have a MitoPRO 300X, pull out the table top stand and place on a level surface.



## GETTING STARTED:

# MitoPRO X Series

**Step 2b:** If you have a MitoPRO 750X or a MitoPRO 1500X and would like to hang your panel on a door, attach the included steel cables to the top of the panel.

Then attach the door hook onto a door and hang.

Optional vinyl straps are included to add length. Vinyl Straps can be doubled up for added hanging security. Straps can also be folded over to create a shorter length (use carabiner on both sides).



### Step 3:

Connect the power cable into the plug located on the back of the unit. And then connect to an outlet. Turn the power switch on (orange switch).



## GETTING STARTED: MitoPRO X Series

Your MitoPRO X has touch screen control.

From the home screen you can:

- 1) Press the M button to select the mode
- 2) Press the Dimming button to change brightness
- 3) Press the Alarm button to set the clock and/or alarm
- 4) Toggle Bluetooth on / off

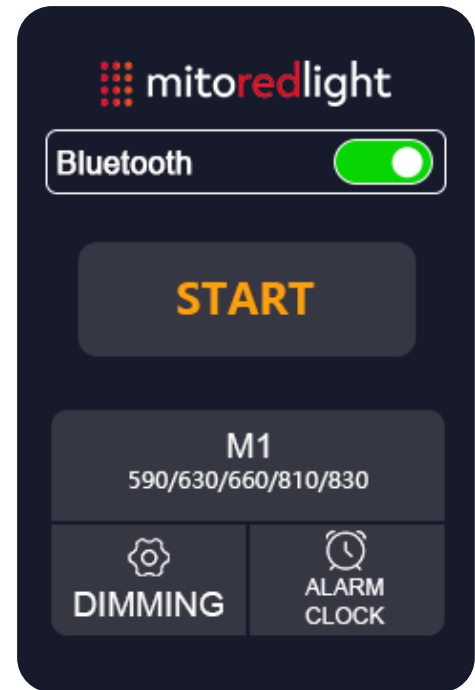

## GETTING STARTED: MitoPRO X Series

### 1 - Press the M button to go to the mode selection screen

M1: The panel will emit all 5 wavelengths (recommended for most use cases)

M2: The panel is entirely red and yellow light (590nm, 630nm, 660nm)

M3: The panel is entirely Near Infrared light (810nm, 830nm)

Please Note: M3 is the ENTIRE PANEL operating at NIR. Since NIR is invisible, to prevent unintentional extended exposure, M3 is limited to 5 minutes on the control panel.

To use all NIR mode for more than 5 minutes, you may use "NIR Extend" Mode (M4) within the Mito Red Light app. NIR Extend mode can be set for up to 20 minutes but will cycle to M2 for one minute, every 4 minutes.

Hit the + or - to change the time then hit 'OK'  
Hit the 'START' button to begin your session.

To pause your session press 'PAUSE'.

To stop your session press 'STOP' and then the 'back' button.

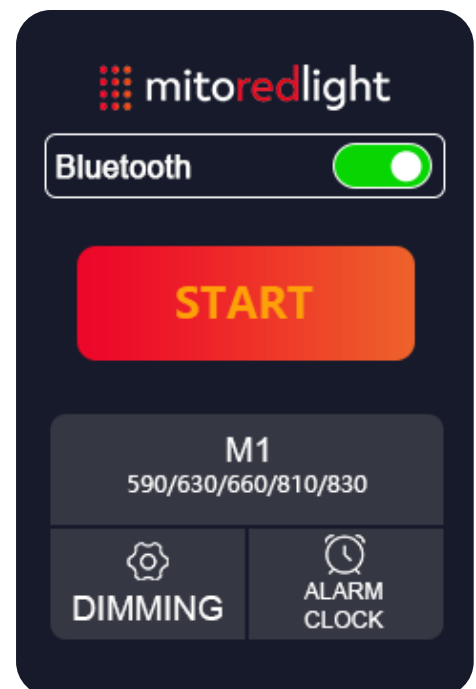
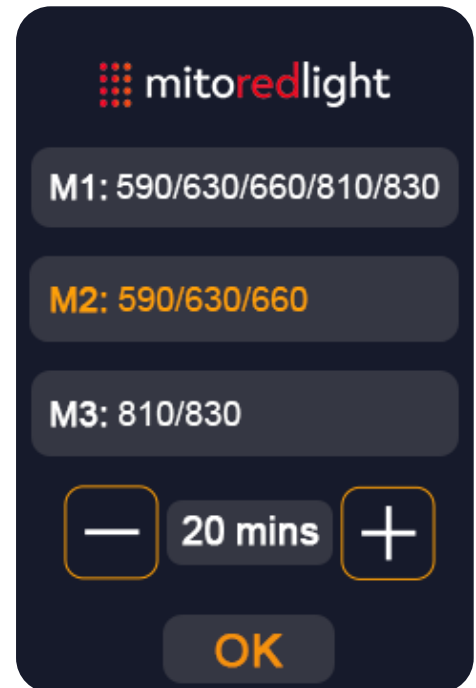

## GETTING STARTED: MitoPRO X Series

### 2 - Changing the Brightness

Press the Dimming button

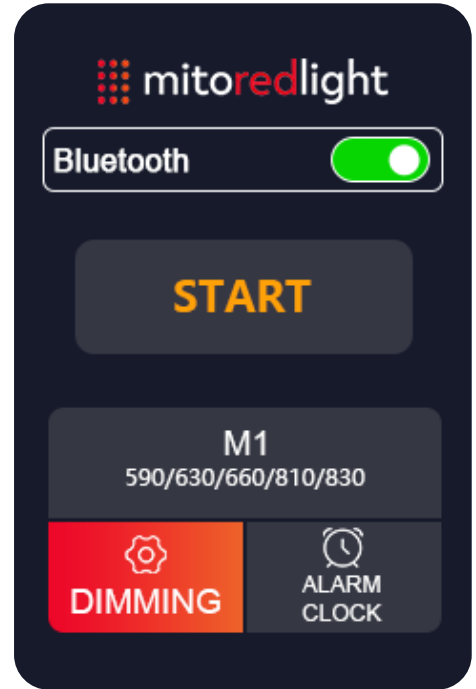

You will be able to slide the brightness up and down from 1% - 100% for both Red and Near Infrared

It is recommended to check the brightness each session to make sure the panel is set at the desired power output.

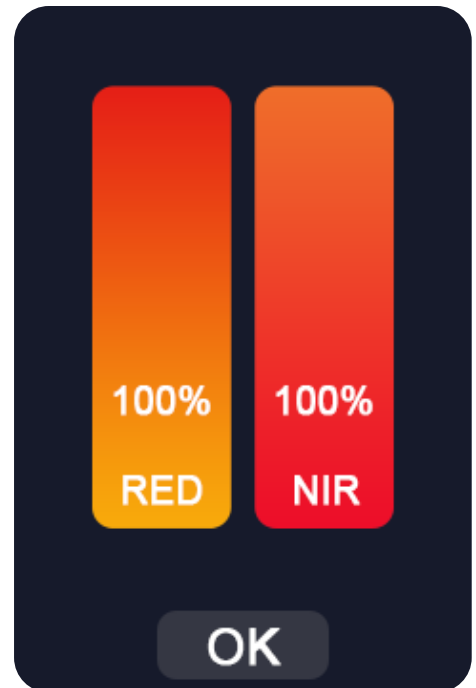

## GETTING STARTED: MitoPRO X Series

### 3 - Setting the Time and Alarm

The built in clock and alarm function allows you to have the light turn on at a predetermined time.

Keep your MitoPRO 300X on your nightstand and wake up to the soothing glow of red light each morning!

Keep your red light panel in your workspace and set alarms throughout the day to remind you take a stretch break, go for a walk or have a short red light therapy session break of course!

To configure the time or alarm, press the Alarm Clock Button on the home screen

The top box displays the current time.

To set the time, press the top box (in red).

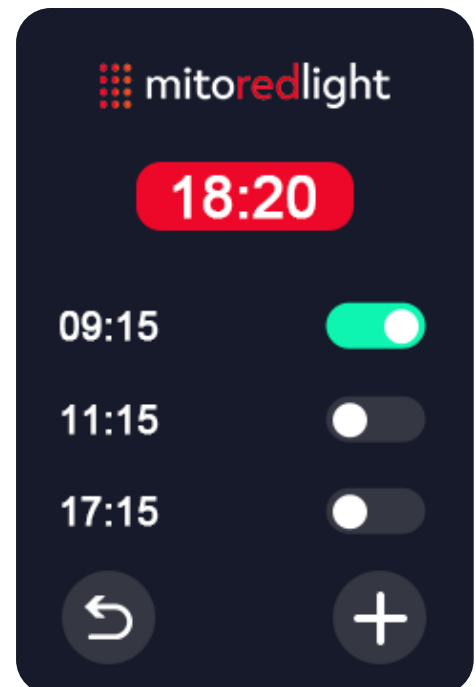
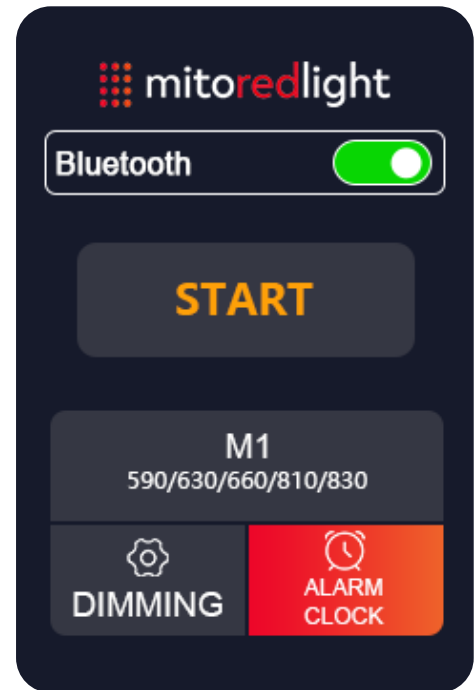

## GETTING STARTED: MitoPRO X Series

### 3 - Setting the time

After pressing that button, you will see the screen to the right.

Set the time to the current time and then press OK.

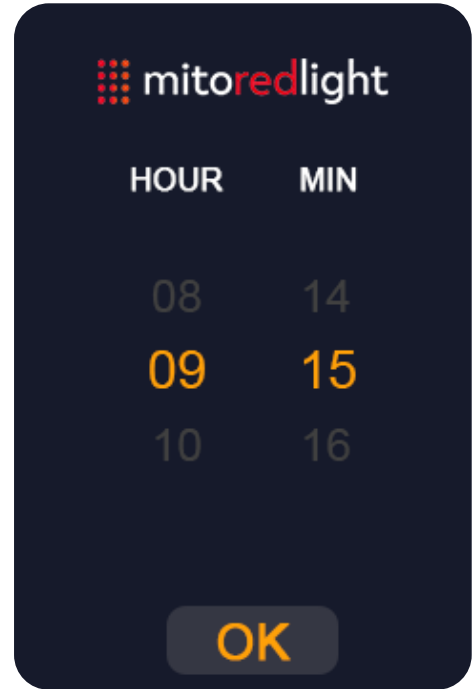

### Setting the Alarm Times

After pressing OK you will be taken back to this screen.

Below the current time (red box) are the times that an alarm is scheduled

You may toggle the alarms on or off as desired.

To change the alarm times, touch the alarm time and adjust as needed

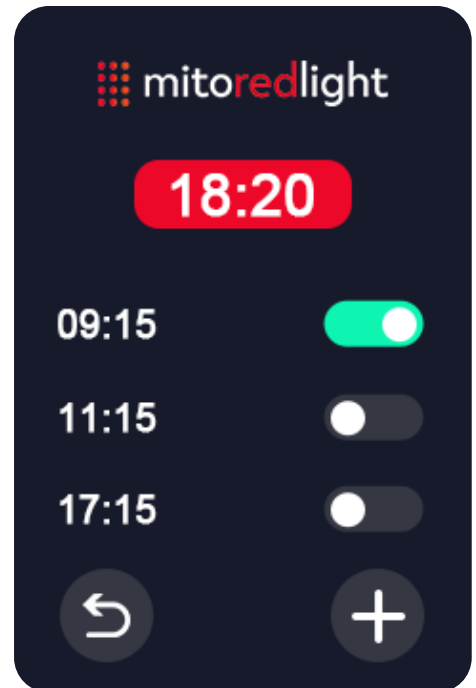



# MOBILE APP USER GUIDE

## DOWNLOADING THE MITO RED LIGHT APP

Make sure the Bluetooth function is enabled on your device or Master Controller (if applicable)

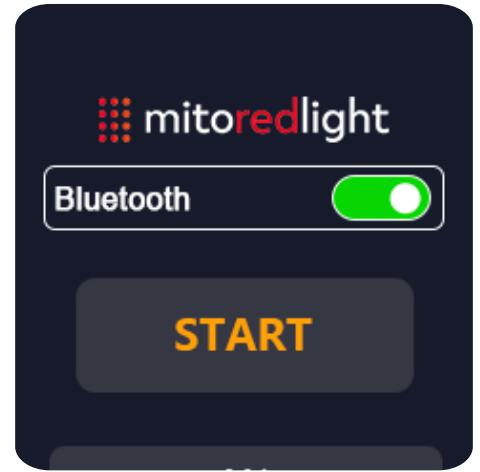

Download the Mito Red Light app by searching the app store, using the link or by scanning the QR codes below!



<https://apps.apple.com/us/app/mitoredlight/id1639752291>



<https://play.google.com/store/apps/details?id=com.mitoredlight&pli=1>

# MOBILE APP USER GUIDE

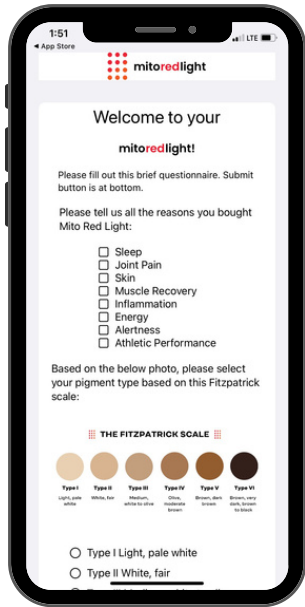

Once downloaded, start the app and fill out our quick questionnaire. Your feedback is greatly appreciated!

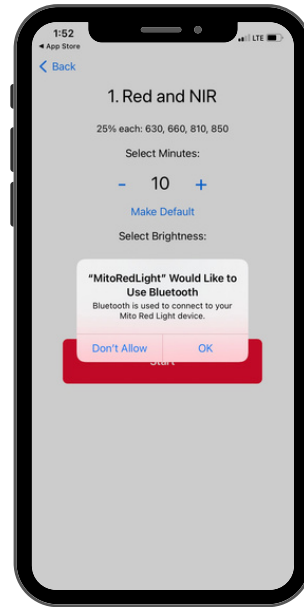

Ensure that Bluetooth permissions are accepted when prompted, if not accepted the app will not connect to your device.

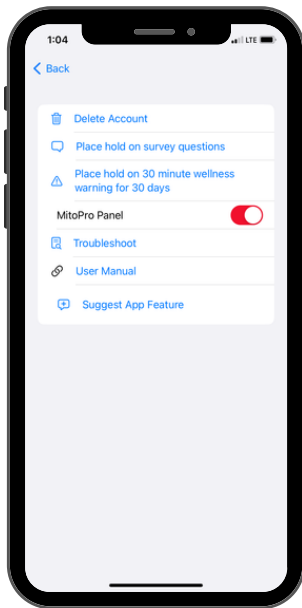

Go to settings and turn 'on' the MitoPRO option

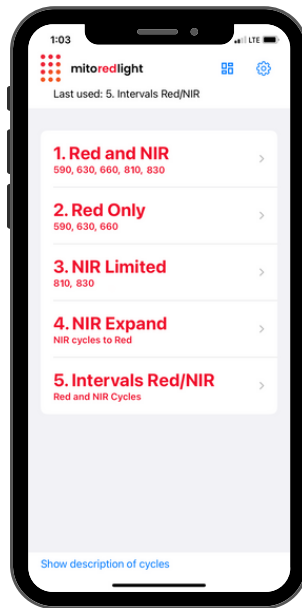

Select one of the 5 modes.

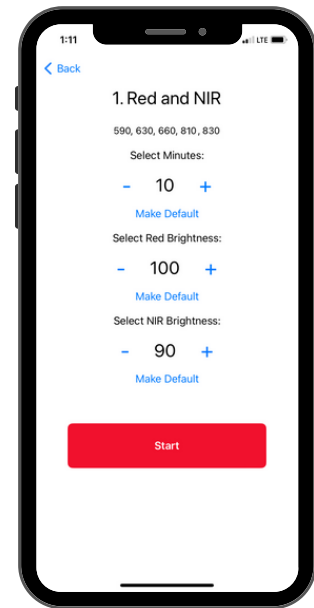

Adjust your time and brightness settings then hit the start button to begin your session.

# APP TROUBLESHOOTING

## TROUBLESHOOTING

If the control panel is not working, make sure you are connected to power and that the power switch on the back of the device is turned on.

If there is no light coming from the panel when the session is started, confirm that the brightness setting is not set to 0% (also note that NIR light 810nm/830nm is invisible to the naked eye).

If app failed to connect, make sure you are within 5 feet of the panel, close the app on your device and restart.

Turn the panel off and on. Make sure your Bluetooth permissions are accepted through your devices' settings. Ensure Bluetooth is enabled on your mobile device and your panel.

If the app still does not connect, go to the settings screen in the app and make sure the toggle says MitoPRO and not MitoADAPT

You can also access this User Manual via the app by clicking the settings icon.

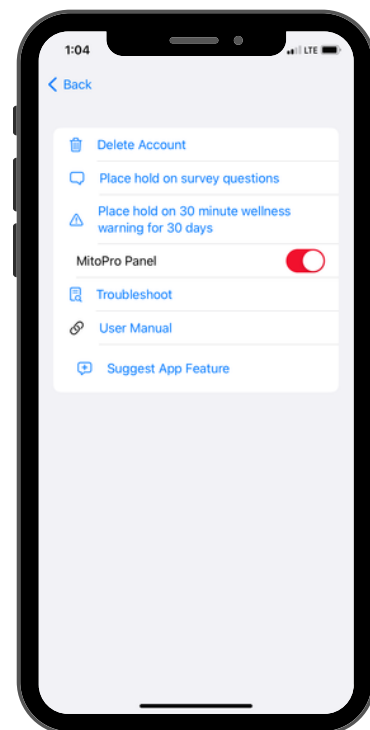
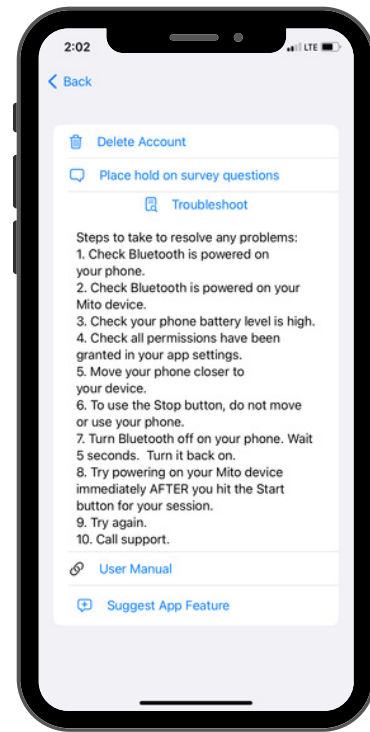

# MitoPRO X Multiple Panels

## CONNECTING POWER TO TWO OR MORE PANELS

**Step 1:** Power can be daisy-chained to 2 or more panels with the included connecting power cord.

NOTE: No more than 4 panels (MitoPRO 1500X or smaller) should ever be connected in a daisy chain power set up (due to the total wattage draw).

XL Panels should always have their own individual power cord and dedicated outlet / circuit.

**Step 2:** Use the Master Controller to control multiple panels. See next page.



# MitoPRO X Master Controller

## CONTROLLING TWO OR MORE PANELS FROM A SINGLE INTERFACE

We know you will love your red light sessions, that you will wonder why you didn't get a bigger panel.

Don't worry - we have designed the MitoPRO X so you can add on additional panels.

Either connect them with brackets on a door, floor stand or universal stand and create your dream red light set-up!

To control multiple devices, you will need the external MitoPRO X Master Controller

Simply plug a standard ethernet cord (included) into the output port of the controller and plug the other end into the ethernet port on the back of the device that you would like to control. Repeat this step for each device in your array.

Now you will be able to control up to four MitoPRO X panels from a single external interface!

The Master Controller touch screen interface is the same as the control panel on the device - so device operation is the same.

Built in magnets in the Master Controller allow you to hang it on the side or top of a panel.



# MITOPRO X FLOOR STAND INSTRUCTIONS

This is a quick start guide. Please see Floor Stand User Manual for full Floor Stand assembly instructions.

**Step 1:** You will need to remove the lower two rubber feet from the back of your unit using a small philips head screwdriver before installation into the floor stand. Then screw on castor wheels.



**Step 2:** Insert your light into the Floor stand and ensure it is seated properly.

Then use the two large white screws to secure the panel inside the stand.



**Important note:** ensure the panel is fully seated into the bottom of the stand by pushing downwards on the top of the panel.



# MITOPRO X XL PANEL

Due to the size and weight of the XL panels they should only be installed as below:



## MEGA

Floor mount (secure to wall with L bracket),  
vertical stand or horizontal stand.

### Floor to wall mounting:

Attach the 4 double ended screws to the top of the panel. Place panel up against wall in the final position it will be mounted in. Install the L bracket by aligning groves and sliding as shown in the pictures.

### WARNING!

The floor to wall mounting bracket is designed to allow the bottom of the panel to be rested on the floor and with the top of the panel secured against the wall. This bracket is not intended to support the weight of the light suspended off the floor!



# MITOPRO X XL PANEL

Secure to wall using appropriate screws (ie drywall screws, etc) or if going into brick or concrete use the provided anchors. Screws or anchors will be installed in the remaining 4 grooves pointed to in the image below



Supplied anchors for brick or concrete only (included)



Hollow wall anchor kit for drywall (not included)



4" wood screw for mounting against wood or going into a stud (not included)



# VERTICAL STAND BRACKET PLACEMENT

**Step 1:** Screw the vertical stand mounting brackets to panel as shown (single panel example)

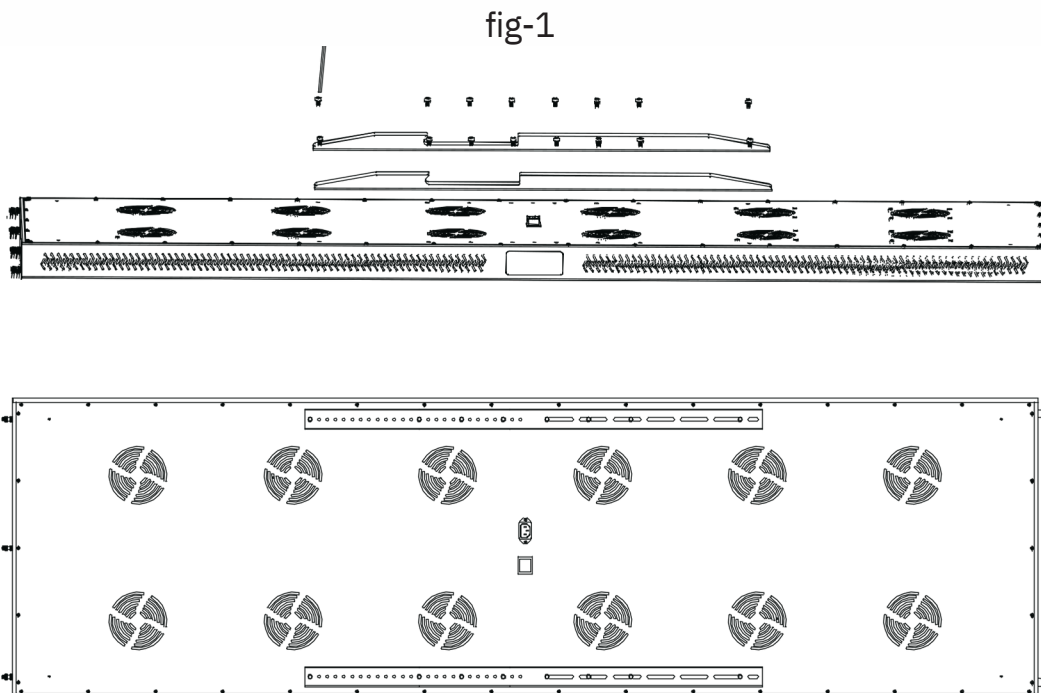
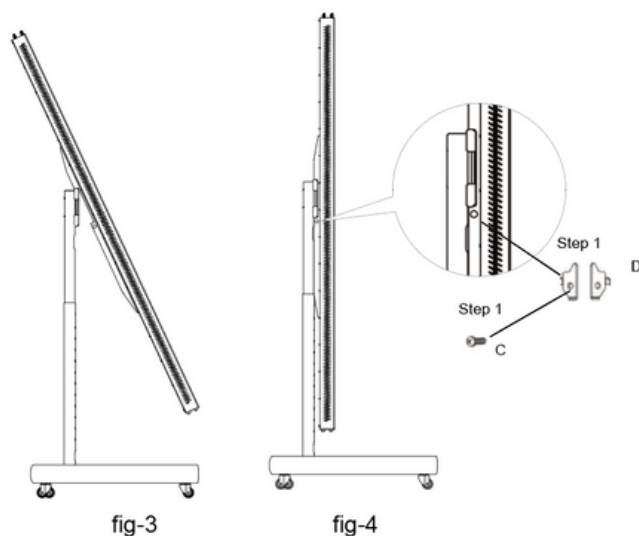

fig-2

\*\* See product specific user manuals / video tutorials for bracket install instructions as the brackets vary by Series.

<https://mitoredlight.com/pages/user-manual>



**Step 2:**

Hang the panel (with vertical mounting brackets) on the cross bracket. Then to secure the panels to the stand, install parts C and D on each side of the vertical brackets as shown (fig-4).

# VERTICAL STAND

## KEY FINAL ASSEMBLY TIP

**Step 1:** Align the attachment as shown in the image to the below.



**Step 2:** Screw in the attachment. Location of the attachment on the stand is shown in the image below.

The holes for the screws and attachments are located on the outside of the outer brackets.



---

Some helpful assembly videos are available here: <https://mitoredlight.com/pages/user-manual>

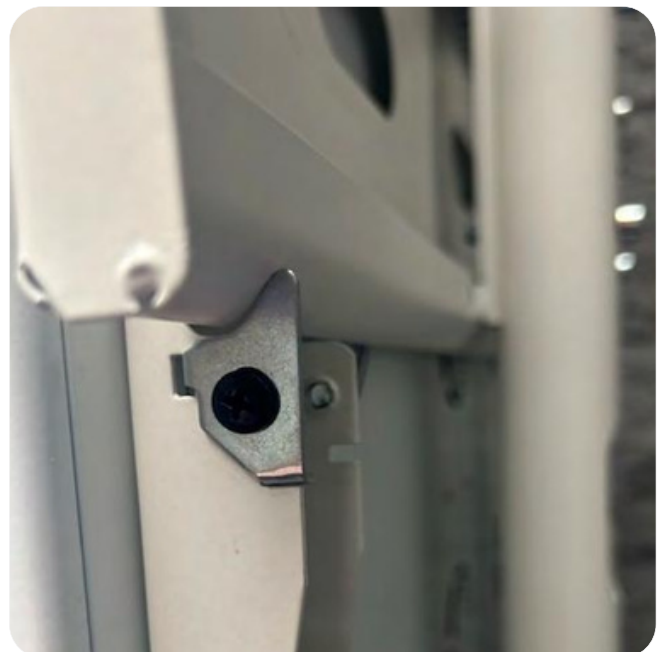

# HORIZONTAL STAND BRACKET PLACEMENT

**Step 1:** Screw horizontal metal brackets to panel. \*note - see product specific user manuals / video tutorials for bracket install instructions as the brackets vary by Series - <https://mitoredlight.com/pages/user-manual>

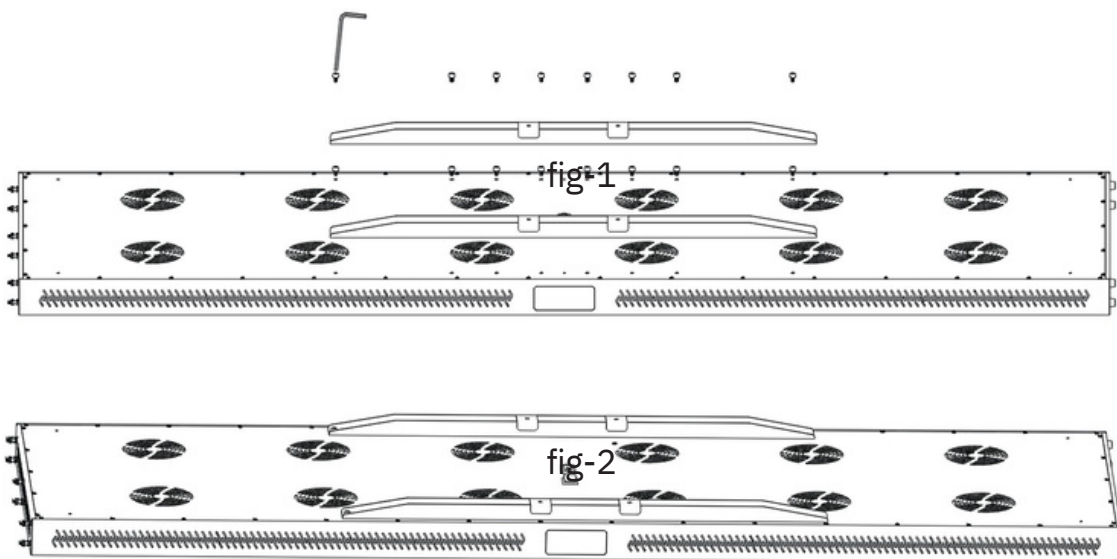

**Step 2:** Fix panel (with horizontal metal bracket attached) with bolts as shown below:



fig-3



fig-4

# LIGHT THERAPY OVERVIEW



## What is Red and Near Infrared Light Therapy?

Red and near-infrared light are part of the electromagnetic spectrum, and more specifically, part of the spectrum of light emitted by the sun. These wavelengths of light are “bioactive” in humans.

Below is a chart outlining the electromagnetic spectrum:

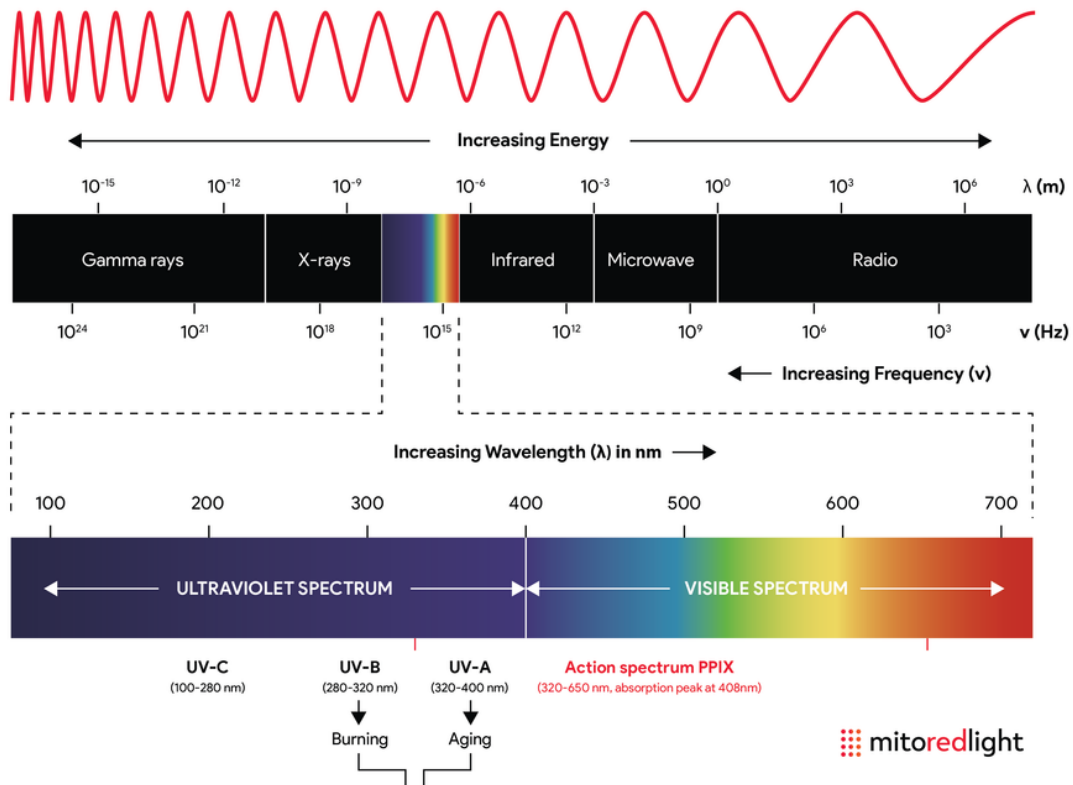

If you remember high school physics, when you pass white light through a prism it separates out the different colors based on their wavelengths (ROYGBIV). Only a tiny part of this spectrum (roughly 400nm to 700nm) is actually visible to the human eye.

# LIGHT THERAPY OVERVIEW



## VISIBLE LIGHT SPECTRUM CHART

NATURAL VISIBLE LIGHT SPECTRUM IN NANOMETERS

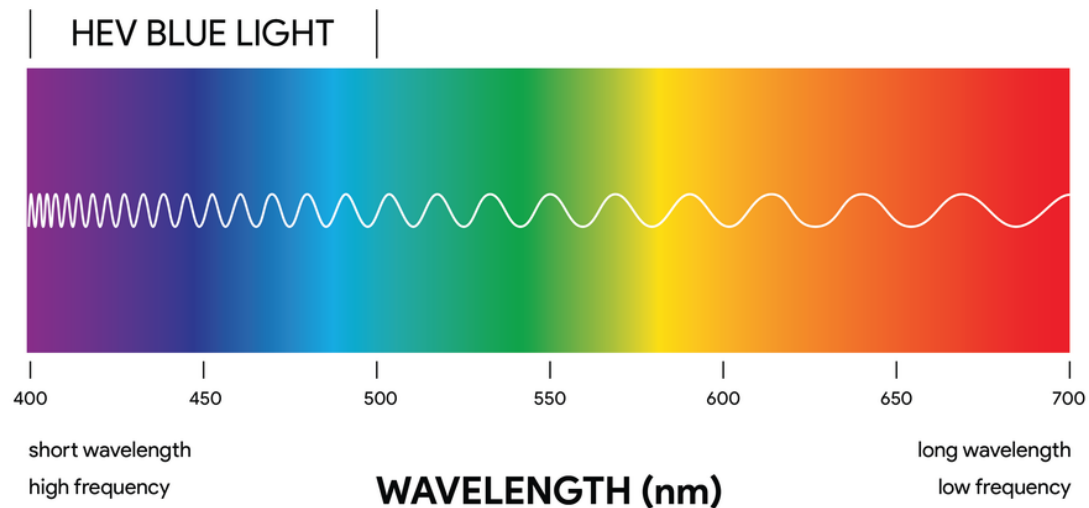

At the highest end of the visible light spectrum is red light, which goes from a little over 600nm to approximately 700nm. Above the visible light spectrum is near-infrared (NIR) from about 700nm to a little over 1,100nm.

It is specifically these red and near-infrared wavelengths that have amazing effects on our bodies. Most research showing benefits of red light and near-infrared light have used wavelengths in the ranges of 620-680nm and 800-880nm.

There have now been literally thousands of studies done in both animals and humans. Overall, red and near infrared light has been repeatedly shown to have

positive effects on cell function in animal and human studies and aid in improving a wide range of conditions.

It's all about PENETRATION.

Most wavelengths of light (UV, blue, green, yellow, etc.) are unable to penetrate into the body - instead they stay in the layers of the skin.

However as the picture above shows, red and near-infrared light are able to penetrate deeper into the human body and are able to reach the cells, tissues, blood, nerves, into the bones and even into the brain!

# LIGHT THERAPY OVERVIEW

**The benefits of red light:** Red light between 600–700nm offers benefits for skin texture and tone, smoothing fine lines and wrinkles, promoting collagen production and generally rejuvenating the appearance of skin and hair.

**The benefits of near-infrared light:** Near-infrared light (NIR) 700nm - 1100nm penetrates deeper into the tissues to assist with wound healing, muscle recovery, nerve injury and joint pain.

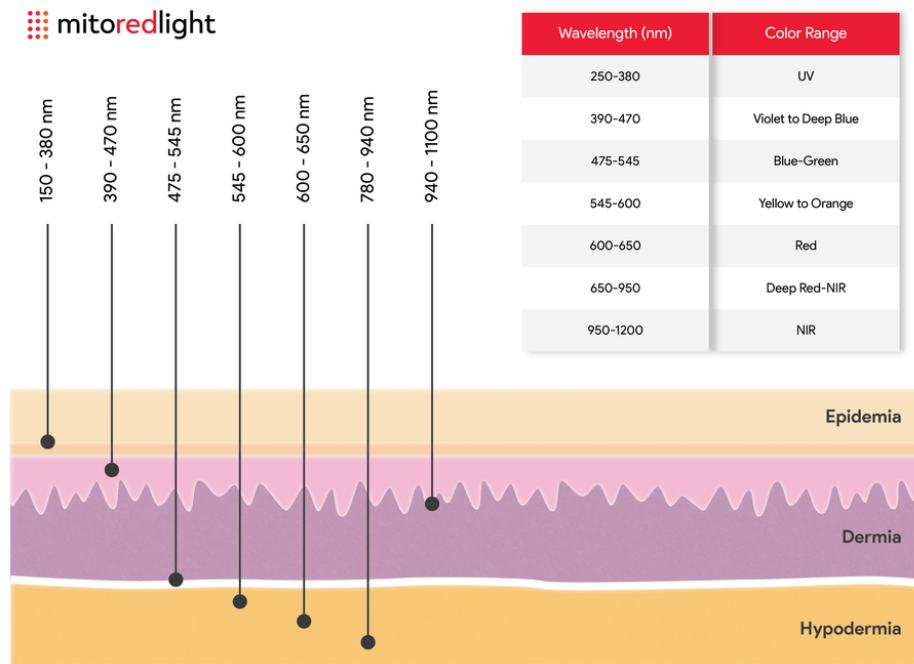

## RED LIGHT BOOSTS CELLULAR ENERGY PRODUCTION

The most well studied mechanism of action surrounding red and near infrared light therapy is increased MITOchondrial energy production in the cells.

MITOchondria are tiny organelles that are the energy power plants of all the cells in our body. Red and near infrared light therapy helps the MITOchondria create more of that energy.

The specific photons found in red and near infrared light interact with a

photoreceptor within our cells called cytochrome c oxidase. This interaction stimulates the mitochondria in our cells to use oxygen more efficiently, which allows the mitochondria to produce more ATP (adenosine triphosphate). Adenosine triphosphate is a complex organic chemical that provides energy to drive many processes in living cells, e.g. muscle contraction, nerve impulse propagation, and chemical synthesis. Found in all forms of life, ATP is often referred to as the "molecular unit of currency" of intracellular energy transfer. When our cells have more energy, they simply perform better and the body follows suit!

# SAFETY INSTRUCTIONS, WARNINGS, AND DISCLAIMER

To preserve the life and functionality of the light, always store in a cool, dry place when possible. For proper use and safety, please be sure to read this manual and follow all instructions and do not do any of the following:

DO NOT let children use the device without adult supervision.

DO NOT use this on infants.

DO NOT let sleeping, disabled, or unconscious persons use the device.

DO NOT exceed 20 minutes of use in one therapy session.

DO NOT use on open, fresh wounds.

DO NOT use in combination with liniments, salves, ointments, or balms that contain heat producing ingredients. A skin burn could be the result of doing so.

DO NOT modify or attempt to repair this equipment. There are no parts that are serviceable by the user. The Mito Red Light is an electrical device. To avoid electric shock and other electricity-related dangers, adhere to the following instructions:

DO NOT wash electrical parts with water or other liquids.

DO NOT drop your device in water or other liquids or place it where it may fall into water or other liquids.



DO NOT expose to running water. If your light comes into contact or becomes submerged into water or other liquid, unplug it immediately from the electrical power outlet. If it is to be used in the vicinity of water, we recommend using an electrical outlet protected by Ground Fault Circuit Interrupter (GFCI).



DO NOT directly touch the light or touch the plugs or switches with wet hands.

DO NOT apply or touch the light to, or with, wet or damp skin.

DO NOT pull, carry, or lift the light by its cord. If the cord is damaged, don't use the light.

DO NOT use on or near heated surfaces.

DO NOT operate this light in areas where it could be exposed to flammable or combustible products or vapors. Explosion or fire may occur.

DO NOT store or use your device in hot temperatures exceeding 130 degrees Fahrenheit.

DO NOT use your light if it is damaged. Continuous use of a damaged light may result in electric shock or injury.

DO NOT use extension cords unless they are designed to carry the total wattage of the light being powered.

DO NOT unplug by pulling directly on the cord. Grasp the plug itself, not the cord, when unplugging from an outlet.

DO NOT cover the cooling fans while operating the light.



# CAUTIONS & DISCLAIMER

## CAUTIONS

Mito Red Light® recommends consulting with your healthcare provider prior to use if you believe that you are sensitive to light. Some cold and allergy medications, pain medications, and medications used to treat infection may cause light sensitivity.

We also recommend consulting with your healthcare provider prior to using the light if you are pregnant, have any suspicious or cancerous lesions, or have recently had a steroid injection or use topical steroids.

If you experience discomfort or have a concern about the light, stop use immediately and contact your healthcare provider.

Unplug from outlet when not in use to avoid tripping hazards.

## DISPOSAL

The light should not be disposed of with other household waste. The light requires disposal via a designated collection point for the recycling of electrical waste.

Please recycle your equipment at the time of disposal to help conserve natural resources and protect human health and the environment.

## DISCLAIMER

The statements in this manual have not been evaluated by the Food and Drug Administration (FDA). The information provided is not intended to diagnose, treat, cure, or prevent any disease and should not be construed as medical advice. Our products are low-risk, general wellness / fitness products.

Mito Red Light makes no claims or representations or otherwise warranties regarding the ability of this product to cure any physical or mental conditions. A qualified health professional should always be consulted prior to using this product in regards to any condition that may require medical attention.

## **CALIFORNIA PROP 65 REQUIRES THE FOLLOWING NOTICE WARNING:**

The enclosed hardware and power cord contain chemicals (such as lead) known to the State of California to cause cancer and birth defects or other reproductive harm. This is true of virtually all power cords and electronics sold in the marketplace at this time. Please wash hands after use.

# WARRANTY POLICY

## PRODUCT SPECIFIC WARRANTY POLICIES:

### 1 YEAR WARRANTY

Portable Red Light Therapy Devices / Flexible Red Light Therapy Devices

### 2 YEAR WARRANTY

Mito Red Original 2.0  
MitoMIND

### 3 YEAR WARRANTY

MitoPRO X Series,  
MitoPRO+ Series,  
MitoADAPT 2.0 Series

The Warranties above are valid only to original purchaser if item purchased directly from [www.mitoredlight.com](http://www.mitoredlight.com) or authorized reseller and is non-transferable. The warranty period starts the date the original purchased unit is delivered.

The warranty covers any defects in material or workmanship under normal use during the warranty period. During the warranty period, Mito Red will replace, at no charge, products that prove defective because of improper material or workmanship, under normal use and maintenance.

Mito Red will replace the products at no charge. For the first 180 days, Mito Red will be responsible for all shipping costs related to your request. After the first 180 days, buyer will be responsible for product shipping charges and related coverage while in transit to Mito Red. Please retain the tracking information for proof of delivery to us.

The warranty does not cover any problem that is caused by damage resulting from



your negligence, improper maintenance, improper use, experimental use, or modifications; the warranty does not cover theft or loss of the product.

To obtain warranty service, you must first contact us at [info@mitoredlight.com](mailto:info@mitoredlight.com) to determine the problem and the most appropriate solution for you. You may be asked to provide proof of any defects, and therefore you should maintain photos and videos of any alleged defects.

# REFUND POLICY

Mito Red offers a full 60-day trial of all products. The 60-day trial period commences upon customer's receipt of the product. Return shipping is paid by you. We require that returns be sent back in the original packaging to prevent damage in transit. You shall retain the tracking information to provide proof of delivery to Mito Red. Mito Red is not liable for lost or damaged return shipments and we reserve the right to charge for any damages you caused to the product.

Refunds for customers choosing to return during the 60-day trial period are 100% of product cost – any elective expedited shipping costs and international shipping costs are non-refundable.

Returns must note your full name and order number. Returns must be postmarked before the end of the 60-day trial period. Returns after the 60-day trial period will not be accepted.

If the returned product is damaged in any way or returned in an unsellable condition, the shipment will be refused and returned to sender.

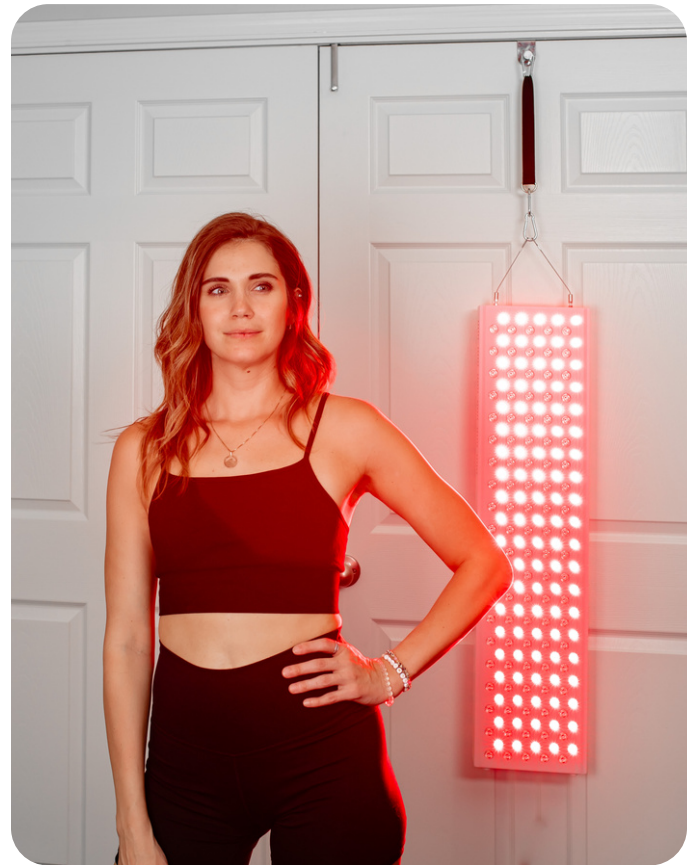

## Return Shipping

To return your product, you should mail your product to:

Mito Red Light, Inc  
9319 N 94th Way, Suite 400  
Scottsdale, AZ 85258

No RMA is required. Please reference your name and order number on the return label.



[www.mitoredlight.com](http://www.mitoredlight.com)



User Manual and Instructional Videos  
This user manual and instructional videos can be found here:  
<https://mitoredlight.com/pages/user-manual>

Updated January 2024

**FOLLOW US!**

