



 mitoredlight

USER MANUAL

MitoPRO+ Series

www.mitoredlight.com

© 2024 MRL IP Holdings LLC. All rights reserved.



TABLE OF CONTENTS

ABOUT US	3
GETTING STARTED	4
CONTRAINDICATIONS	5
FAQs	8
GETTING STARTED: MITOPRO+ SERIES	12
MITOPRO+ REMOTE CONTROL	14
MITOPRO+ FLOOR STAND INSTRUCTIONS	15
MITOPRO+ DOOR HANGING INSTRUCTIONS	17
MITOPRO 300+ STAND INSTRUCTIONS	18
MITOPRO 300+ STAND REMOVAL	19
MITOPRO+ XL SERIES	21
VERTICAL STAND BRACKET PLACEMENT	24
HORIZONTAL STAND BRACKET PLACEMENT	26
LIGHT THERAPY OVERVIEW	27
PRODUCT COMPARISON	30
SAFETY INSTRUCTIONS, WARNINGS, AND DISCLAIMER	31
CAUTIONS & DISCLAIMER	33
WARRANTY POLICY.....	34
REFUND POLICY	35

ABOUT US

Located in Scottsdale, Arizona, **Mito Red Light**® is dedicated to bringing the highest powered, highest quality red light therapy lights to market at the best possible value.

Having extensively studied and realized the benefits of red light therapy firsthand, Mito Red Light was brought into existence in order to provide consumers truly affordable, yet highly effective red light therapy options.

If you have any further questions, please feel free to contact us at:
info@mitoredlight.com

You can also call our phone number
Monday - Friday 9am - 5pm MST
+1 866-861-6486

Mail correspondence can be sent to:
Mito Red Light, Inc
9319 N 94th Way, Suite 400 Scottsdale, AZ 85258

GETTING STARTED

INDICATIONS FOR USE

Mito Red Lights are general wellness devices and are not intended to cure or diagnose any medical conditions. Use of this device is designed to help promote overall health and wellness by supporting cellular function. Mito Red Lights should only be operated based on the user guidelines, as outlined in this user manual.

FIRST TIME USERS

For first time users, we recommend starting out with 2-3 minute sessions per area, and slowly working up to a 10-minute session over the course of 2-3 weeks as your body acclimates to the therapy.

STANDARD USE

MitoPRO+ Series: We recommend 10-minute sessions at 12-18 inches from your device.

Additional 10-minute sessions for specific areas may be beneficial but beyond a certain point, the scientific evidence points to diminishing returns. More is not always better.



For this reason, we recommend you allow at least 6 hours between sessions on the same area. We recommend no more than 15 minutes in any one session. We recommend using the device 4-6 times per week. We recommend taking at least one day off per week.

Because the LEDs are very bright, eye protection should be worn when looking directly towards the light, particularly when NIR is active.

MAINTENANCE

The Mito Red Light® does not require any maintenance beyond basic care and regular cleaning. Cleaning the light is easy, just unplug the light and wipe the surface with a cloth or paper towel. Do not use harsh cleaning chemicals or bleach because they may damage the light. Make sure the light is dry before using it again. For safety, the light is only intended for use indoors.

CONTRAINDICATIONS

CONTRAINDICATIONS FOR RED LIGHT THERAPY

There are no industry-wide accepted contraindications for red light therapy or list of accepted contraindications that is designated or enforced by regulatory agencies. Research in red light therapy is ongoing, and contraindications are derived from existing research and clinical inferences.



POTENTIAL HAZARDS

Heat - Red light therapy will generate thermal energy as light is absorbed. This heat may present a hazard in some conditions.

Light - The electromagnetic radiation used in red light therapy is low in energy, but it may affect tissues that are sensitive to light.

Tissue Stimulation - Red light therapy is intended to stimulate tissues. In some disease states this may be undesirable.

ABSOLUTE CONTRAINDICATIONS

Recent Burns - Recent burns may still contain residual thermal energy that may be increased by heat from red light therapy.

Malignant Cancers - There is a theoretical risk that red light therapy may increase cell proliferation in malignant cancers.

Hyperthyroidism (Neck & Upper Chest) - Red light therapy on the neck and upper chest may increase thyroid activity in those with hyperthyroidism.

Pregnancy (Abdomen) - The effects of red light therapy that reaches a developing fetus are not fully understood and may potentially have a negative effect.

Eye Disease (Eyes) - Red light therapy's effects on various eye conditions is not fully understood and light sensitive cells in the eyes may respond unfavorably to intense red light.



Light Sensitivity - Individuals with rare conditions causing extreme sensitivity to light or who have previously reacted to red light therapy should avoid its use.

RELATIVE CONTRAINDICATIONS

Fever or Infection - There is a theoretical risk that the use of red light therapy can worsen existing hyperthermia caused by fever or infection.

Systemic Lupus Erythematosus (SLE) - SLE can cause skin sensitivity, increasing the risk of a reaction to red light therapy.

Severe Bleeding or Blood Loss - Some research suggests that red light therapy may slow the body's ability to stop bleeding.

Use of Photosensitizing Medications - Medications that increase sensitivity to light may increase risks of sensitivity to red light therapy.

Tattoos - Red light therapy may cause cosmetic defects to body art, especially body art that uses red inks may be prone to fading when exposed to intense red light. The tattoo ink may also cause uneven absorption of red light, causing therapy to be less uniform.

Dark skin pigmentation - The effect of skin pigmentation on red light therapy is still being studied. Those with darker skin tones may find that their skin absorbs more light, making it warmer than those with lighter skin tones would experience. A smaller amount of red light may actually reach deeper tissues, however, this effect is not likely to be large.



Dark hair - Darker colors of hair may absorb more light, causing increased warmth and decreased penetration of red light. This effect is not likely to be large.

Melasma / Hyperpigmentation - Our own product study showed improvement from red and NIR light on hyperpigmentation, particularly when paired with a high antioxidant serum. However, in rare instances users can experience the opposite effect. We suggest starting slowly and using red light only if this is a concern.

A detailed discussion of this can be found in our article: Red Light Therapy & Hyperpigmentation.

Anyone with a contraindication to red light therapy (or any health condition at all) should consult with their physician before using red light therapy.

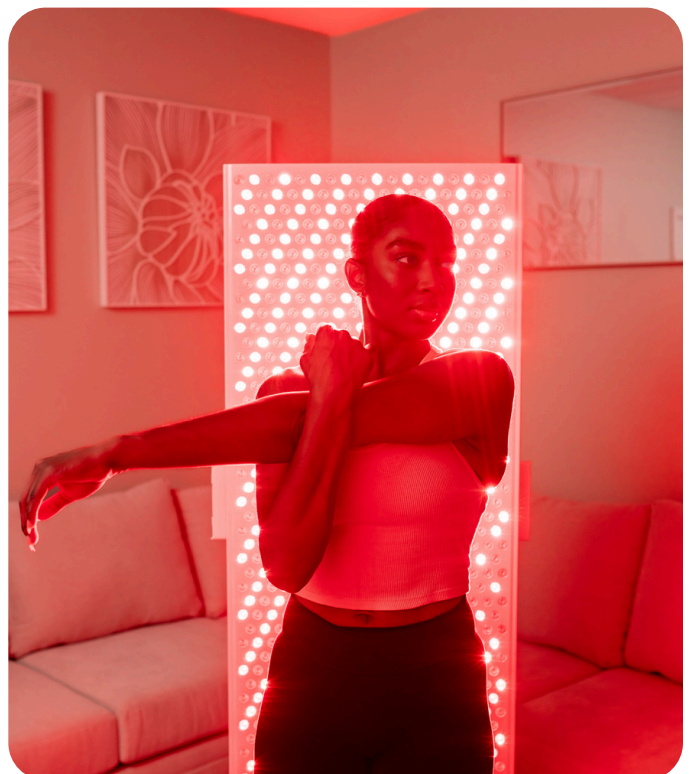

FAQS

IS RED LIGHT THERAPY SAFE? ARE THERE SIDE EFFECTS?

Mito Red Light uses only the red and near infrared wavelengths that are clinically proven to be effective and safe. However, we always recommend consulting with your healthcare provider for specific questions about any concerns or health conditions.

DO I NEED SAFETY GLASSES WITH THIS LIGHT?

While there is a growing body of scientific research suggesting that modest amounts of red and NIR LED light may benefit certain eye conditions, Mito Red's plug-in lights are very bright! As such, eye protection is provided and should be worn when facing the lights, particularly when NIR is active.

WHEN USING, DO NOT STARE DIRECTLY INTO THE LIGHT EMITTING DIODES (LEDS).

Again, our Mito Red Lights are very bright and if you have any eye problems, or any other health conditions at all, please consult with a licensed healthcare professional before using a device like Mito Red.



ARE THE NIR LEDS NOT WORKING?

NIR is just beyond the visible spectrum and is invisible to the naked eye. You will only actually be able to see a pink dot, or a subtle pink glow emanating from the LEDs when they are on. Please rest assured that there is a significant amount of light energy emanating from those LEDs and your Mito Red Light is in fact working exactly as designed.

WILL LIGHT THERAPY TREATMENTS CAUSE DETOX SYMPTOMS?

It is possible that a Mito Red Light session can cause some detox related symptoms while your body acclimates. If you experience these types of issues, we recommend stopping use until the symptoms go away. Then start out at 2-3 minutes per session area and work your

way slowly up to 10 minutes over the course of 2-3 weeks. This will help your body adapt. If you continue to experience detox-related symptoms and have any concerns regarding the use of red light therapy, we recommend stopping use and consulting with your healthcare provider.

We have a full 60-day no hassle trial and full refund policy.



WHAT IF MY SKIN IS BURNED OR DAMAGED?

Red light therapy has been clinically-proven to help damaged skin heal from cuts, burns, and other blemishes. We recommend consulting with your healthcare provider if you have any concerns.

As we are not licensed healthcare practitioners, we are not able to offer

definitive clinical guidance. We recommend consulting with your trusted health care provider with specific questions.

WHAT IF I HAVE A PRE-EXISTING HEALTH CONDITION OR TAKE MEDICATIONS?

Mito Red Lights are classified as a general wellness devices. Out of an abundance of caution, we recommend you consult with your healthcare provider if you have any pre-existing conditions or if you take photosensitizing drugs. Steroids work to suppress the immune system while red light therapy may work to stimulate it. To the extent that the two therapies may work against each other, we do not recommend they be used together.

CAN CHILDREN USE MITO RED LIGHT®?

Clinical studies have shown red and NIR light therapy to be quite safe. However, if you are considering using it with children, we recommend consulting with a healthcare professional. All treatments with children should be done under adult supervision.

CAN PREGNANT OR NURSING WOMEN USE THE LIGHTS?

As there has been no clinical research with red light therapy treatments on pregnant or nursing subjects, do not use the device if pregnant or lactating before consulting with your healthcare provider.

OTHER CONSIDERATIONS: BOTOX, BREAST IMPLANTS AND LASIK

Users with a history of facial fillers and/ or Botox injections should consult their dermatologist prior to use.

Users with breast implants should consult their plastic surgeon prior to use.

Do not use the device during the healing period post Lasik eye surgery. Before resuming use, we recommend getting clearance from your doctor. As always, we recommend following our user guidelines and making sure to use the provided goggles when facing directly into the light panel.

ARE THE NIR LEDS NOT WORKING?

NIR is just beyond the visible spectrum and is invisible to the naked eye. You will only actually be able to see a pink dot, or a subtle pink glow emanating from the LEDs when they are on. Please rest assured that there is a significant amount of light energy emanating from those LEDs and your Mito Red Light is in fact working exactly as designed.

Helpful tip: For peace of mind, take out your phone and take a picture of your panel with the NIR on only. You will see the bulbs illuminating.

Please note: The 'yellow' 590 nm light may look green as the eyes and brain adjust to the bright light. It is completely normal for the 590nm LEDs to appear green at times.

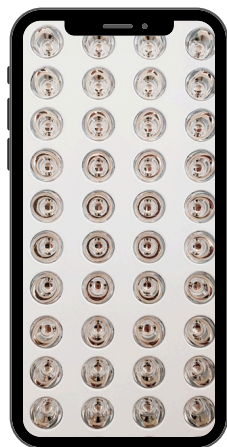

Panel off
(through camera lens)

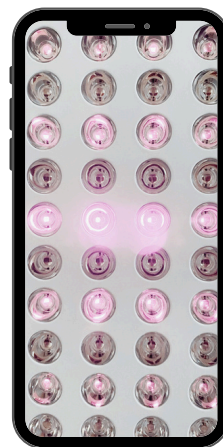

NIR on only
(through camera lens)



GETTING STARTED: MitoPRO+ Series

Step 1: Unbox your MitoPRO+ device and accessories.

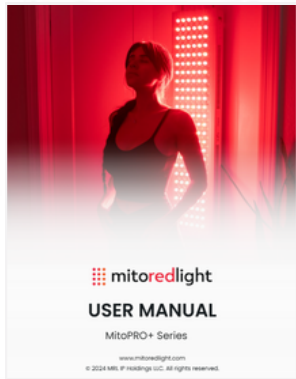

- 1 x user manual
- 1 x power cord
- 1 x eye protection goggles
- 1 x eye protection glasses
- 1 x over the door hook
- 1 x hanging cables
- 2 x small vinyl straps
- 2 x large vinyl straps
- 1 x daisy chain power cord

Step 2: Attach to stand (see page 16), or use the over the door hook and attach either the steel cable or material straps. Two of each size vinyl strap are included. Vinyl Straps can be doubled up for added hanging security. Material straps can also be folded over to create a shorter length (use carabiner on both sides).

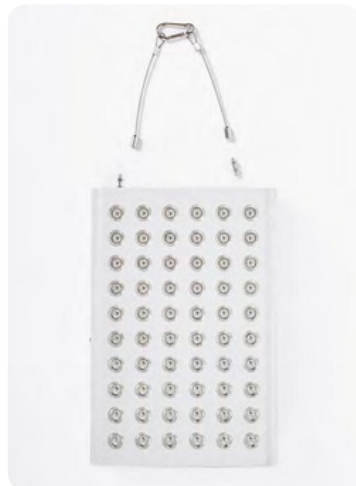

GETTING STARTED: MitoPRO+ Series (CONTINUED)

Step 3: To operate your new MitoPRO+ device.

Plug in device and turn the power switch on (orange switch).

Step 4: Hit the 'Mode' button to program the session.

A = Red Light only

I = Near Infrared Light only

A I = Red and Near Infrared Light

Step 5: Press the 'Time' button to select the desired session time.

When powered on the timer defaults to 10 minutes.

When pressing the 'time' button the timer will count up to 20 minutes then start over at 1 minute.

Step 6: To start your session Hit the 'OK' and the timer will automatically start counting down until the session ends. To end your session early, press the 'OK' button and switch off at the back of the panel.



Some Mito tips:

- For first time users, we recommend starting out with 2-3 minute sessions per area, and slowly working up to a 10-minute session over the course of 2-3 weeks as your body acclimates to the device.
- Always ensure you are wearing the included eyewear protection when facing the panel when in use.
- Near Infrared (NIR) is invisible to the naked eye - some customers think the panel is not working, but if you take the device into a dark room and take a photo - you will see a small red/purple hue of light which indicates the NIR is working just as designed.

MitoPRO+ REMOTE CONTROL

CONNECTING POWER TO TWO OR MORE PANELS

Step 1: Power can be daisy-chained to 2 or more panels with the included connecting power cord. Panels may use a daisy chain power cord to power multiple units, however, as the panels do not communicate with each other, you will need to operate each panel individually. or use the remote.



NOTE: No more than 4 panels (MitoPRO 1500+ or smaller) should ever be connected in a daisy chain power set up (due to the total wattage draw). XL Panels should always have their own individual power cord and dedicated outlet / circuit.

Attention: The MitoPRO 300+, 750+, 1500+ will be packaged with 16 AWG power cord. The XL panels will be supplied with a 14 AWG. If you need a replacement power cord, please contact customer service.

Step 2: Use the remote control to control the panels. If the panels ever go out of sync press the 'Reset' button, to reset the settings on all panels to the default (10 minutes, red and near infrared active).

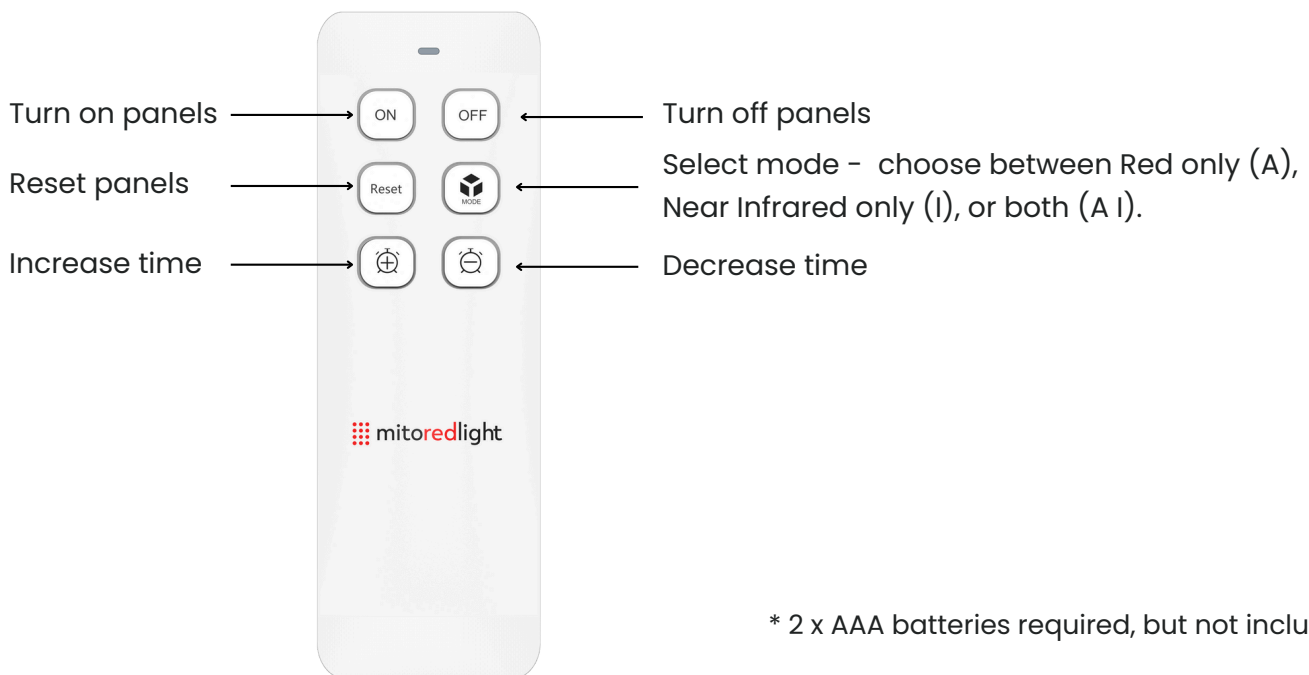

MITOPRO+ FLOOR STAND INSTRUCTIONS

SINGLE PANEL

This is a quick start guide. Please see Floor Stand User Manual for full Floor Stand assembly instructions.

Step 1: You will need to remove the lower two rubber feet from the back of your unit using a small Philips head screwdriver before installation into the floor stand. Then screw on castor wheels.



Step 2: Insert your light into the Floor stand and ensure it is seated properly.



Important note: ensure the panel is fully seated into the bottom of the stand by pushing downwards on the top of the panel.





MITOPRO+ DOOR HANGING

As mentioned on Page 12, if you would like to hang your panel from a door, screw the hanging cables onto the top of your panel and use the door hook to hang. Two of each size vinyl strap are included. Vinyl Straps can be doubled up for added hanging security. Material straps can also be folded over to create a shorter length (use carabiner on both sides).

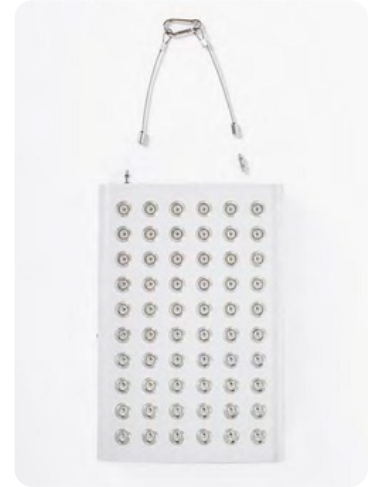

If you need to hang a MitoPRO 750+ with a MitoPRO 1500+ you will need to use brackets to secure the panels together.

In the image to the right we show two sets of MitoPRO 750+'s with two MitoPRO 1500+'s

We recommend placing the MitoPRO 1500+ on top.

Next, remove the white feet from the back of the panel with a Phillips head screwdriver.

Next, use the provided door hang brackets and align so there are at least three screws utilized on the top panel and three on the bottom (on each bracket). Use the screws and allen key provided to attached the brackets to connect the panels as demonstrated.

Use the power connecting cables to power the panels at the same time. And use the remote control to control the panels.



MITOPRO 300+ STAND INSTRUCTIONS

The stand may be rigid when you first receive your MitoPRO 300+. Pull back from top to extend the stand.



To open, firmly push up as shown.

Flip over light and you are ready to go!



MITOPRO 300+ STAND REMOVAL

Remove four screws on outer part of stand with screwdriver.



Remove four screws from the inner plate. Stand can now be removed from the light.



After removing screws grasp stand cover and lift straight up.



If hanging the light on its own, screw the legs to the back of the light.





MITOPRO+ XL SERIES

Due to the size and weight of the XL panels they should only be installed as below:

MEGA - Floor mount (secure to wall with L bracket), vertical stand or horizontal stand.

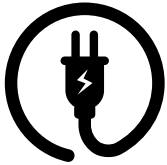

Warning: Please check the power cord, before set up. The power cord must be 14AWG. A power cord smaller than 14AWG cannot be used. Please reach out to our customer service team if you need help obtaining the correct power cord.

Floor to wall mounting:

Attach the 4 double ended screws to the top of the panel. Place panel up against wall in the final position it will be mounted in. Install the L bracket by aligning groves and sliding as shown in the pictures.

The floor to wall mounting bracket is designed to allow the bottom of the panel to be rested on the floor and with the top of the panel secured against the wall. This bracket is not intended to support the weight of the light suspended off the floor!



Panel Mounting (Continued) MITOPRO+ XL SERIES

Secure to wall using appropriate screws (ie drywall screws, etc) or if going into brick or concrete use the provided anchors. Screws or anchors will be installed in the remaining 4 grooves pointed to in the image below



Supplied anchors for brick or concrete only (included)



Hollow wall anchor kit for drywall (not included)



4" wood screw for mounting against wood or going into a stud (not included)

MITOPRO+ XL SERIES

To operate your new MitoPRO+ XL device.

Carefully unbox MitoPRO+ XL device.

Plug in device and turn the power switch on (orange switch).



Hit the 'Mode' button to program the session

A = Red Light only

I = Near Infrared Light only

A I = Red and Near Infrared Light

Press the 'Time' button to select the desired session time.

When powered on the timer defaults to 10 minutes.

When pressing the 'time' button the timer will count up to 20 minutes then start over at 1 minute.

To start your session

Hit the 'OK' and the timer will automatically start counting down until the session ends.

VERTICAL STAND BRACKET PLACEMENT

Step 1: Screw the vertical stand mounting brackets to panel as shown (single panel example)

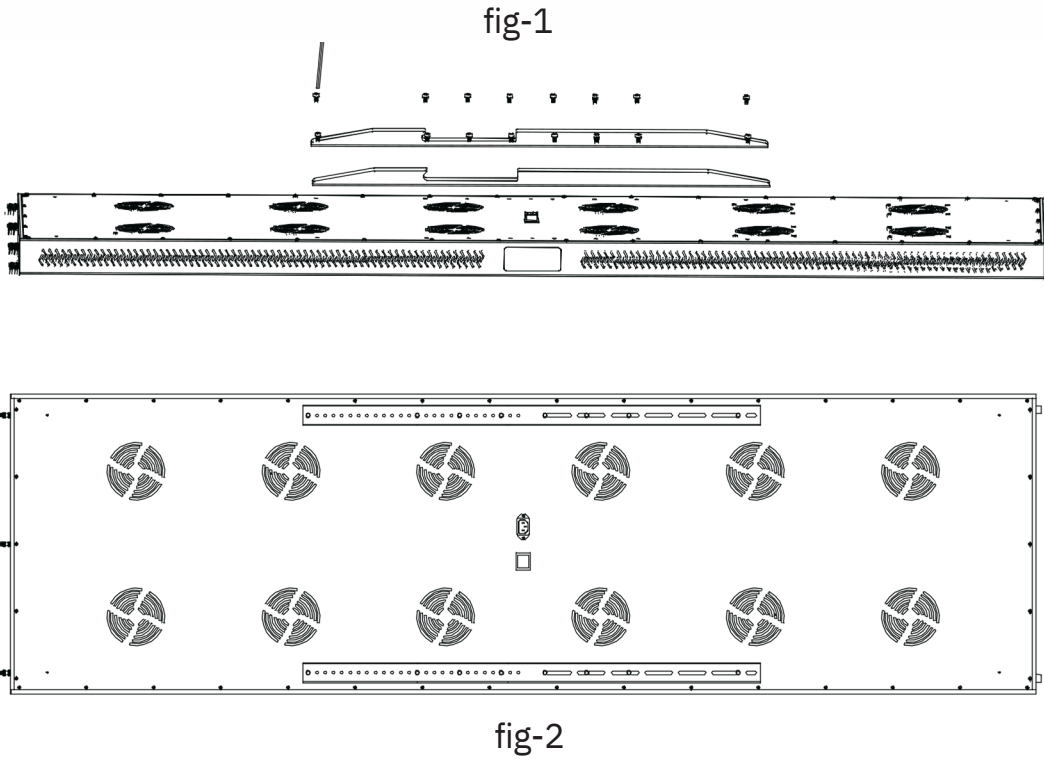

** See product specific user manuals / video tutorials for bracket install instructions as the brackets vary by Series.
<https://mitoredlight.com/pages/user-manual>

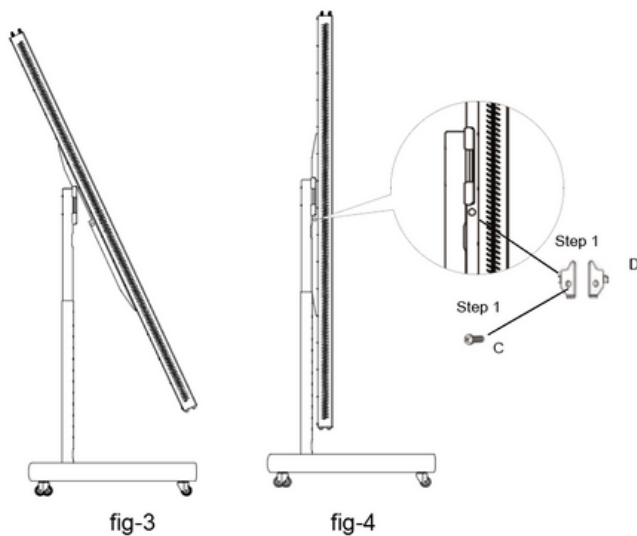

Step 2: Hang the panel (with vertical mounting brackets) on the cross bracket. Then to secure the panels to the stand, install parts C and D on each side of the vertical brackets as shown (fig-4).

VERTICAL STAND

KEY FINAL ASSEMBLY TIP

Step 1: Align the attachment as shown in the image to the below.



Step 2: Screw in the attachment. Location of the attachment on the stand is shown in the image below.

The holes for the screws and attachments are located on the outside of the outer brackets.

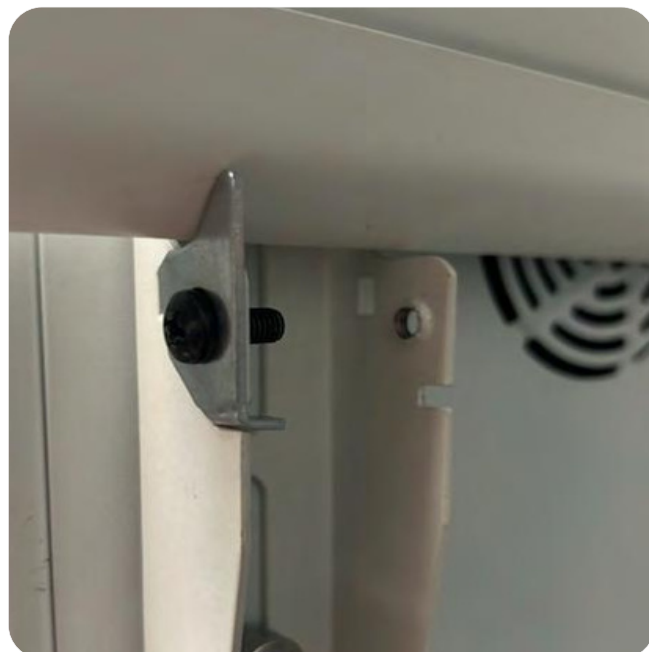

Some helpful assembly videos are available here: <https://mitoredlight.com/pages/user-manual>

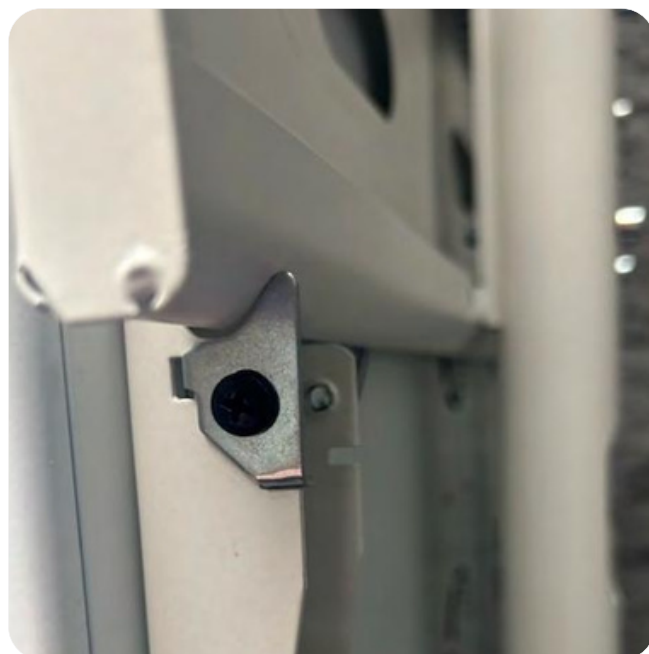

HORIZONTAL STAND BRACKET PLACEMENT

Step 1: Screw horizontal metal brackets to panel. *note - see product specific user manuals / video tutorials for bracket install instructions as the brackets vary by Series - <https://mitoredlight.com/pages/user-manual>

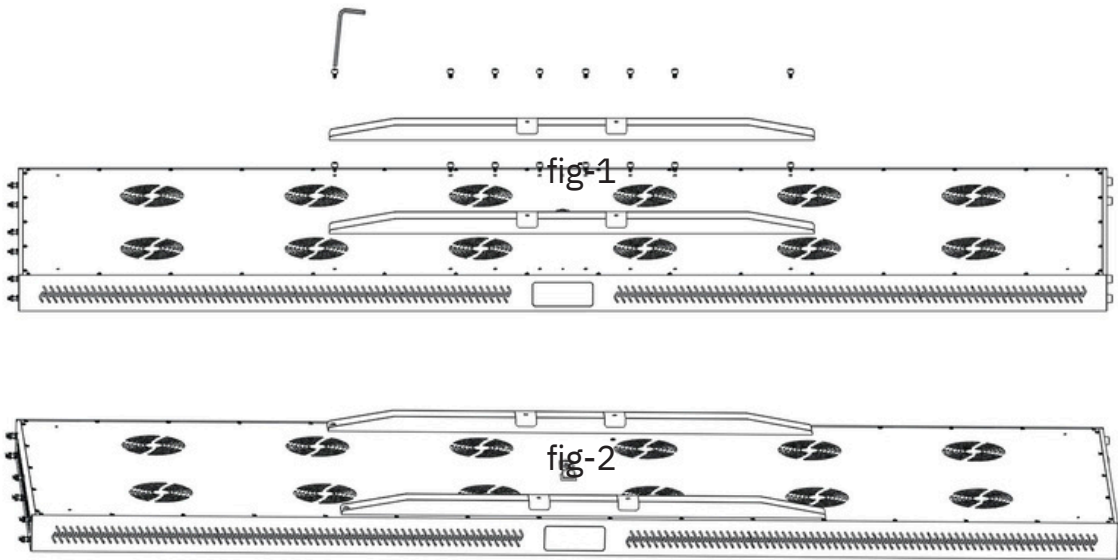

Step 2: Fix panel (with horizontal metal bracket attached) with bolts as shown below:



fig-3



fig-4

LIGHT THERAPY OVERVIEW

What is Red and Near Infrared Light Therapy?

Red and near-infrared light are part of the electromagnetic spectrum, and more specifically, part of the spectrum of light emitted by the sun. These wavelengths of light are "bioactive" in humans.



Below is a chart outlining the electromagnetic spectrum:

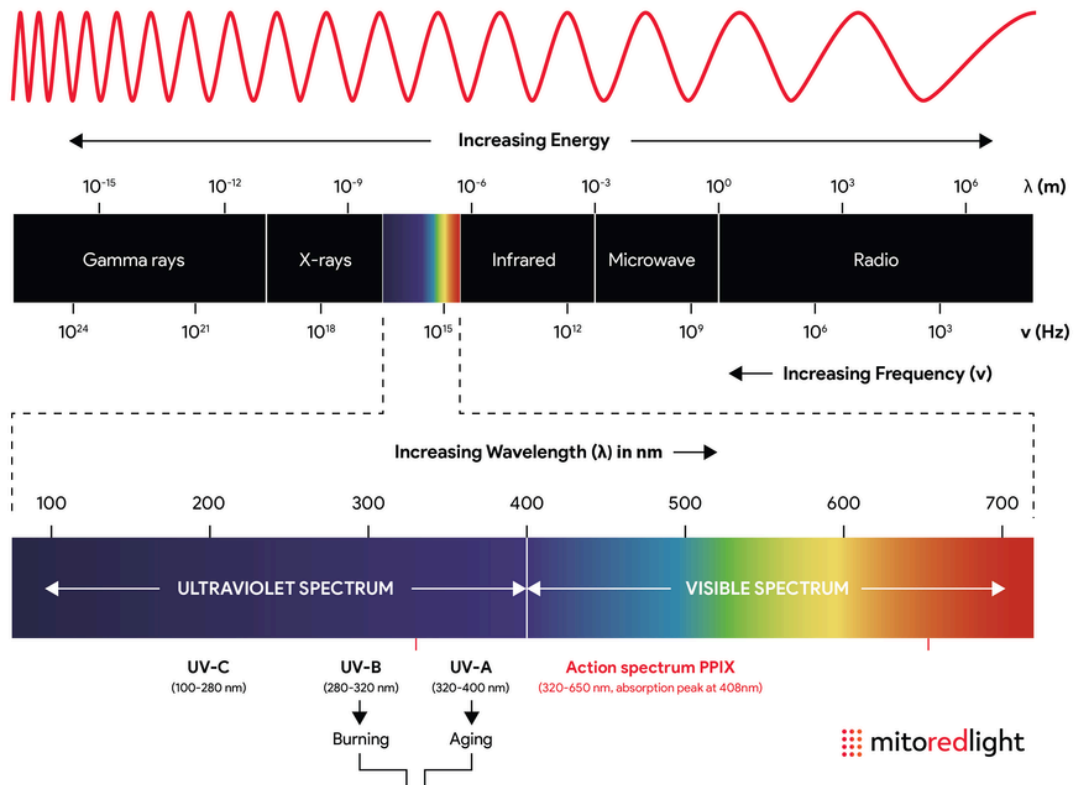

If you remember high school physics, when you pass white light through a prism it separates out the different colors based on their wavelengths (ROYGBIV). Only a tiny part of this spectrum (roughly 400nm to 700nm) is actually visible to the human eye.

LIGHT THERAPY OVERVIEW

VISIBLE LIGHT SPECTRUM CHART

NATURAL VISIBLE LIGHT SPECTRUM IN NANOMETERS

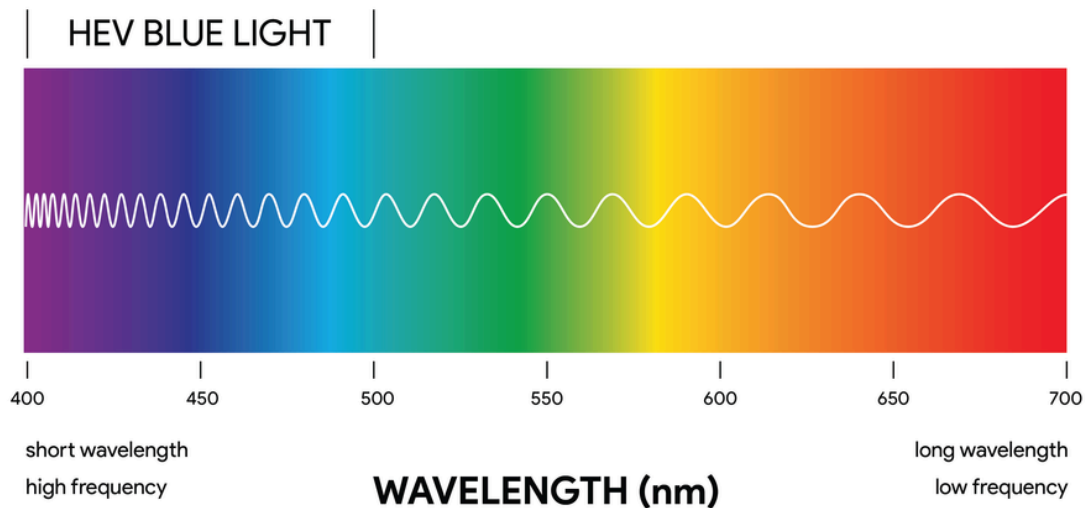

At the highest end of the visible light spectrum is red light, which goes from a little over 600nm to approximately 700nm. Above the visible light spectrum is near-infrared (NIR) from about 700nm to a little over 1,100nm.

It is specifically these red and near-infrared wavelengths that have amazing effects on our bodies. Most research showing benefits of red light and near-infrared light have used wavelengths in the ranges of 620-680nm and 800-880nm.

There have now been literally thousands of studies done in both animals and humans. Overall, red and near infrared light has been repeatedly shown to have

positive effects on cell function in animal and human studies and aid in improving a wide range of conditions.

It's all about PENETRATION.

Most wavelengths of light (UV, blue, green, yellow, etc.) are unable to penetrate into the body - instead they stay in the layers of the skin.

However as the picture above shows, red and near-infrared light are able to penetrate deeper into the human body and are able to reach the cells, tissues, blood, nerves, into the bones and even into the brain!

LIGHT THERAPY OVERVIEW

Red light: Visible to the human eye, red light has wavelengths between 600–700 nanometers (nm) and is most effective on the skin's surface. Red light can improve skin health, collagen production, as well as help with hair growth.

Near-infrared Light: Invisible to the human eye, near-infrared light has wavelengths between 700–1200 nm and can penetrate deeper into the body, acting on the muscles, joints and bone.

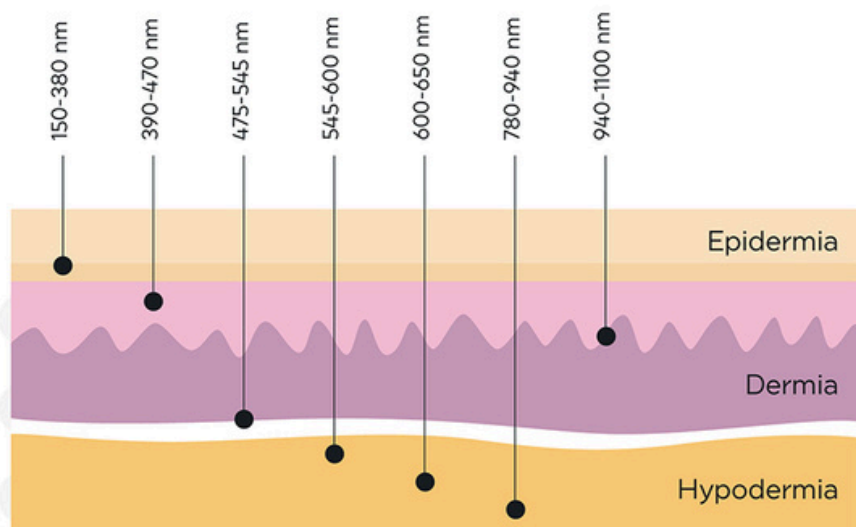

Wavelength (nm)	Color Range
250-380	UV
390-470	Violet-Deep Blue
475-545	Blue-Green
545-600	Yellow-Orange
600-650	Red
650-950	Deep Red
950-1200	NIR

RED LIGHT BOOSTS CELLULAR ENERGY PRODUCTION

The most well studied mechanism of action surrounding red and near infrared light therapy is increased MITOchondrial energy production in the cells.

MITOchondria are tiny organelles that are the energy power plants of all the cells in our body. Red and near infrared light therapy helps the MITOchondria create more of that energy.

The specific photons found in red and near infrared light interact with a

photoreceptor within our cells called cytochrome c oxidase. This interaction stimulates the mitochondria in our cells to use oxygen more efficiently, which allows the mitochondria to produce more ATP (adenosine triphosphate). Adenosine triphosphate is a complex organic chemical that provides energy to drive many processes in living cells, e.g. muscle contraction, nerve impulse propagation, and chemical synthesis. Found in all forms of life, ATP is often referred to as the "molecular unit of currency" of intracellular energy transfer. When our cells have more energy, they simply perform better and the body follows suit!

PRODUCT COMPARISON



MitoPRO 300+

MitoPRO 750+

MitoPRO 1500+

MitoPRO Mega+

Dimensions:	11 x 10 x 3	22 x 10 x 3	42 x 10 x 3	64 x 17 x 3
LED Peak Wavelengths:	630nm, 660nm, 830nm, 850nm	630nm, 660nm, 830nm, 850nm	630nm, 660nm, 830nm, 850nm	630nm, 660nm, 830nm, 850nm
LED Count:	60	150	300	600
*Irradiance at 6 Inches (mW/cm ²)	>130mW/cm²	>165mW/cm²	>170mW/cm²	>105mW/cm²
**Fluence (Joules/cm ² /minute)	2.7	3.3	3.4	2.5
Weight:	7 lbs.	15 lbs.	25 lbs.	60 lbs.
Warranty:	3 Years	3 Years	3 Years	3 Years
Lens Beam Angle:	60 Degrees	60 Degrees	60 Degrees	60 Degrees
Power Consumption:	90w	200w	400w	880W
Best Used For:	Targeted	Half Body	Mostly Full Body	Full Body

*Based on consumer level (solar) light meters. For comparison and reference purposes only.

**Based on professional, independent laboratory testing. Can guide dosing in concert with the guidelines in the user manual.

SAFETY INSTRUCTIONS, WARNINGS, AND DISCLAIMER

To preserve the life and functionality of the light, always store in a cool, dry place when possible. For proper use and safety, please be sure to read this manual and follow all instructions and do not do any of the following:

DO NOT let children use the device without adult supervision.

DO NOT use this on infants.

DO NOT let sleeping, disabled, or unconscious persons use the device.

DO NOT exceed 20 minutes of use in one therapy session.

DO NOT use on open, fresh wounds.

DO NOT use in combination with liniments, salves, ointments, or balms that contain heat producing ingredients. A skin burn could be the result of doing so.

DO NOT modify or attempt to repair this equipment. There are no parts that are serviceable by the user. The Mito Red Light is an electrical device. To avoid electric shock and other electricity-related dangers, adhere to the following instructions:

DO NOT wash electrical parts with water or other liquids.

DO NOT drop your device in water or other liquids or place it where it may fall into water or other liquids.



DO NOT expose to running water. If your light comes into contact or becomes submerged into water or other liquid, unplug it immediately from the electrical power outlet. If it is to be used in the vicinity of water, we recommend using an electrical outlet protected by Ground Fault Circuit Interrupter (GFCI).

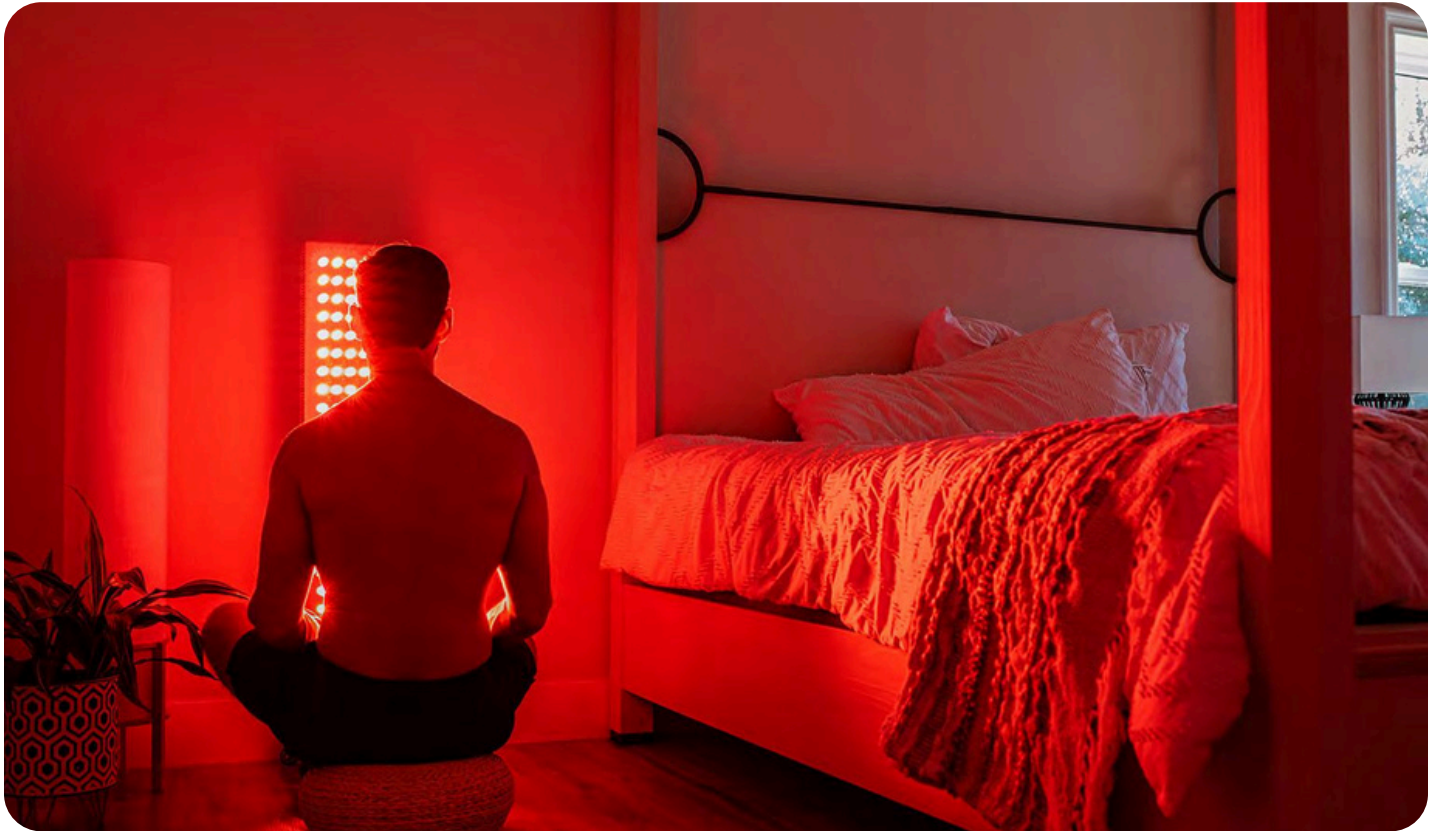

DO NOT directly touch the light or touch the plugs or switches with wet hands.

DO NOT apply or touch the light to, or with, wet or damp skin.

DO NOT pull, carry, or lift the light by its cord. If the cord is damaged, don't use the light.

DO NOT use on or near heated surfaces.

DO NOT operate this light in areas where it could be exposed to flammable or combustible products or vapors. Explosion or fire may occur.

DO NOT store or use your device in hot temperatures exceeding 130 degrees Fahrenheit.

DO NOT use your light if it is damaged. Continuous use of a damaged light may result in electric shock or injury.

DO NOT use extension cords unless they are designed to carry the total wattage of the light being powered.

DO NOT unplug by pulling directly on the cord. Grasp the plug itself, not the cord, when unplugging from an outlet.

DO NOT cover the cooling fans while operating the light.

CAUTIONS & DISCLAIMER

CAUTIONS

Mito Red Light® recommends consulting with your healthcare provider prior to use if you believe that you are sensitive to light. Some cold and allergy medications, pain medications, and medications used to treat infection may cause light sensitivity.

We also recommend consulting with your healthcare provider prior to using the light if you are pregnant, have any suspicious or cancerous lesions, or have recently had a steroid injection or use topical steroids.

If you experience discomfort or have a concern about the light, stop use immediately and contact your healthcare provider.

Unplug from outlet when not in use to avoid tripping hazards.

DISPOSAL

The light should not be disposed of with other household waste. The light requires disposal via a designated collection point for the recycling of electrical waste.

Please recycle your equipment at the time of disposal to help conserve natural resources and protect human health and the environment.

DISCLAIMER

The statements in this manual have not been evaluated by the Food and Drug Administration (FDA). The information provided is not intended to diagnose, treat, cure, or prevent any disease and should not be construed as medical advice. Our products are low-risk, general wellness / fitness products.

Mito Red Light makes no claims or representations or otherwise warranties regarding the ability of this product to cure any physical or mental conditions. A qualified health professional should always be consulted prior to using this product in regards to any condition that may require medical attention.

CALIFORNIA PROP 65 REQUIRES THE FOLLOWING NOTICE WARNING:

The enclosed hardware and power cord contain chemicals (such as lead) known to the State of California to cause cancer and birth defects or other reproductive harm. This is true of virtually all power cords and electronics sold in the marketplace at this time. Please wash hands after use.

WARRANTY POLICY

PRODUCT SPECIFIC WARRANTY POLICIES:

1 YEAR WARRANTY

Mito Mobile / Mito Mobile Flex / Advanced Red Light Therapy Belt

2 YEAR WARRANTY

Mito Red Original 2.0

3 YEAR WARRANTY

MitoPRO+ Series & MitoADAPT Series

The warranties above are valid only to original purchaser if item purchased directly from www.mitoredlight.com or authorized reseller and is non-transferable. The warranty period starts the date the original purchased unit is delivered.

The warranty covers any defects in material or workmanship under normal use during the warranty period. During the warranty period, Mito Red will replace, at no charge, products that prove defective because of improper material or workmanship, under normal use and maintenance.

Mito Red will replace the products at no charge. For the first 180 days, Mito Red will be responsible for all shipping costs related to your request. After the first 180 days, buyer will be responsible for product shipping charges and related coverage while in transit to Mito Red. Please retain the tracking information for proof of delivery to us.

The warranty does not cover any problem that is caused by damage resulting from



your negligence, improper maintenance, improper use, experimental use, or modifications; the warranty does not cover theft or loss of the product.

To obtain warranty service, you must first contact us at info@mitoredlight.com to determine the problem and the most appropriate solution for you. You may be asked to provide proof of any defects, and therefore you should maintain photos and videos of any alleged defects.

REFUND POLICY

Mito Red offers a full 60-day trial of all products. The 60-day trial period commences upon customer's receipt of the product. Return shipping is paid by you. We require that returns be sent back in the original packaging to prevent damage in transit. You shall retain the tracking information to provide proof of delivery to Mito Red. Mito Red is not liable for lost or damaged return shipments and we reserve the right to charge for any damages you caused to the product.

Refunds for customers choosing to return during the 60-day trial period are 100% of product cost – any elective expedited shipping costs and international shipping costs are non-refundable.

Returns must note your full name and order number. Returns must be postmarked before the end of the 60-day trial period. Returns after the 60-day trial period will not be accepted.

If the returned product is damaged in any way or returned in an unsellable condition, the shipment will be refused and returned to sender.



Return Shipping

To return your product, please visit our website FAQ section to initiate a return (RMA).

Once complete our return address is:

Mito Red Light, Inc
9319 N 94th Way, Suite 400
Scottsdale, AZ 85258



www.mitoredlight.com



User Manual and Instructional Videos
This user manual and instructional videos can be found here:
<https://mitoredlight.com/pages/user-manual>

Updated November 2024

FOLLOW US!

